













# Clark County Traffic Control Guide and Sign Designation Manual



# Table of Contents



















**Note:**

Clicking on the County Logo will return you to this page.

	<b>Sign Background Color</b>	
	<b>Chapter 2A</b>	Enhanced Conspicuity
	<b>Chapter 2B</b>	Regulatory
	<b>NDOT</b>	Regulatory
	<b>Chapter 2C</b>	Warning
	<b>NDOT</b>	Warning
	<b>Chapter 2D</b>	Guide - Conventional Roads
	<b>Chapter 2E</b>	Guide - Controlled Access
	<b>NDOT</b>	Guide - Controlled Access
		Overhead Sign Info
	<b>Chapter 2G</b>	Preferential and Managed Lanes
	<b>Chapter 2H</b>	General Information
	<b>Chapter 2I</b>	Service
	<b>NDOT</b>	Service
	<b>Chapter 2M</b>	Recreational
	<b>Chapter 2N</b>	Emergency Management
	<b>Chapter 6</b>	Construction
	<b>Part 7</b>	Schools
		School Typical Layouts
	<b>Part 8</b>	Railroad and Light Rail
	<b>Part 9</b>	Bike Facilities
	<b>Section 11</b>	Trails
	<b>Section 12</b>	Non-Roadway Signs















# Table of Contents

	<b>Section 13</b>	Replace when found
	<b>Section 14</b>	Incorrect Curve/Turn Warning Signs
	<b>Section 15</b>	Signs to be removed
	<b>Section 16</b>	Signs to be upgraded when replaced
	<b>Section 17</b>	Las Vegas Strip only
	<b>Section 20</b>	Sign Post Information and Wind Loadings
	<b>Section 21</b>	Pavement Marking and RPM layouts
	<b>Section 22</b>	Permanent Barricades
	<b>Section 22</b>	Permanent Barricades
	<b>Section 22</b>	Permanent Barricades
	<b>Section 30</b>	Special Lane Patterns
	<b>Section 30</b>	Special Lane Patterns
	<b>Section 31</b>	Controlled Access Facilities Striping
	<b>Section 31</b>	Controlled Access Facilities Striping
	<b>Section 32</b>	Shift and Taper Info
	<b>Section 32</b>	Shift and Taper Info
	<b>Section 33</b>	Sign Type Determination
	<b>Section 33</b>	Sign Type Determination



# Sign Background Color

	Black		Red
	Blue		White
	Brown		Yellow or Fluorescent Yellow
	Green		
	Orange		Purple
	Fluorescent Orange		Fluorescent Pink
	Fluorescent Yellow-Green		

**NOTE:**

1. Only those signs designated in this Manual and the MUTCD may be Fluorescent Yellow-Green background in place of the standard Yellow background.
2. Yellow and Fluorescent Yellow-Green background signs and plates may not be mixed on the same assembly.
3. Fluorescent Orange is required for all Orange except for barricades.





# **Clark County**

# **Enhanced Conspicuity**



# Chapter 2A Enhanced Conspicuity

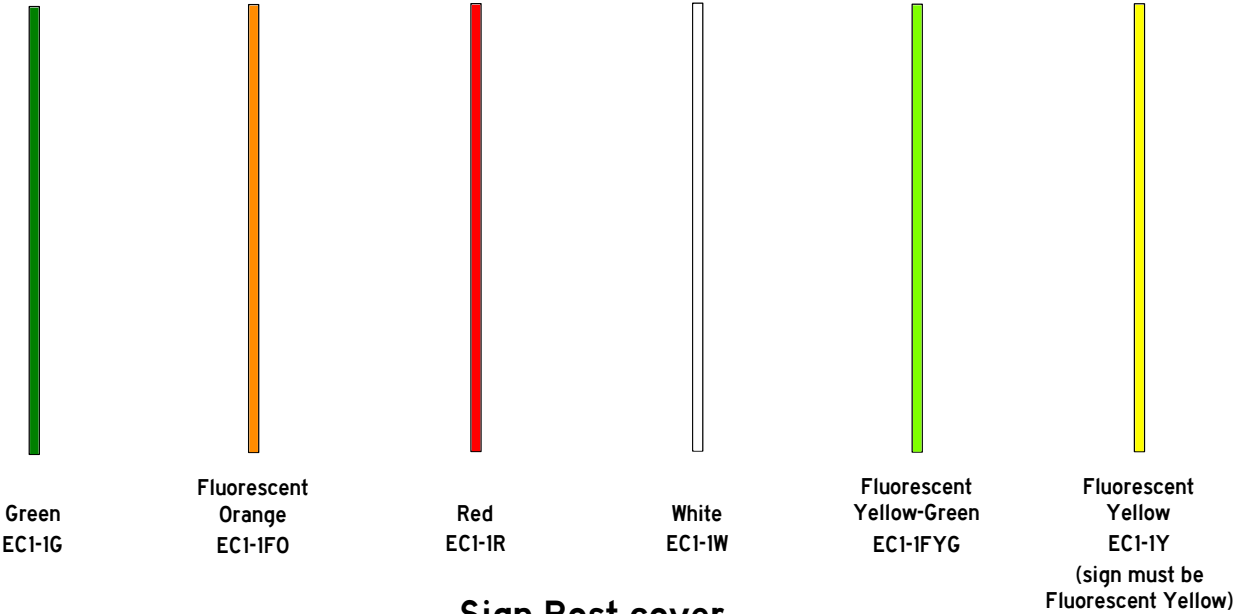

## Sign Post cover Cover shall match background of sign

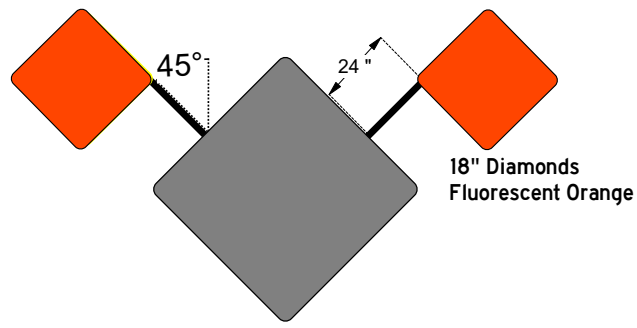
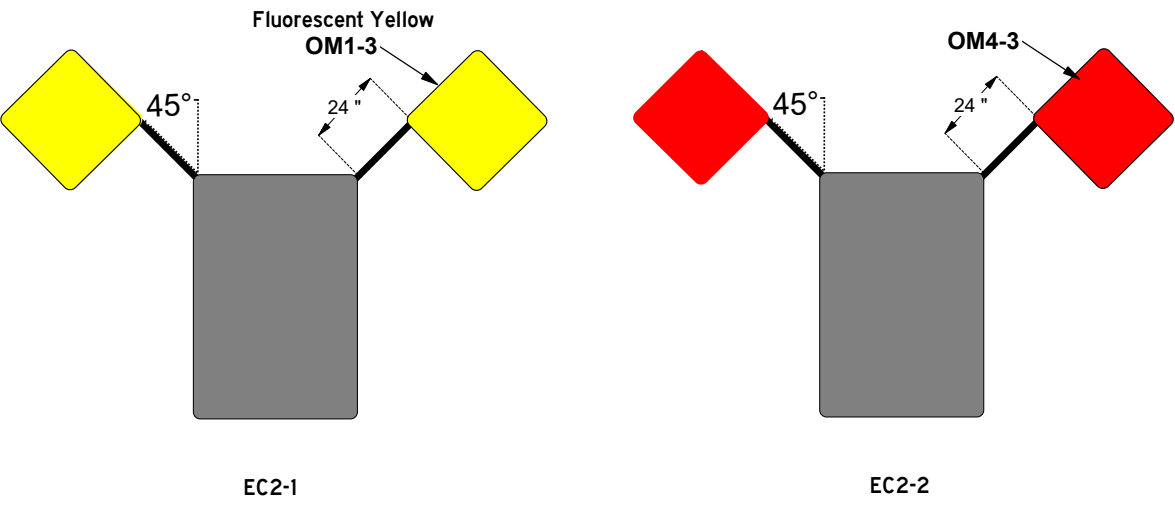

### Construction Work Zones ONLY

EC2-3



# Chapter 2A Enhanced Conspicuity

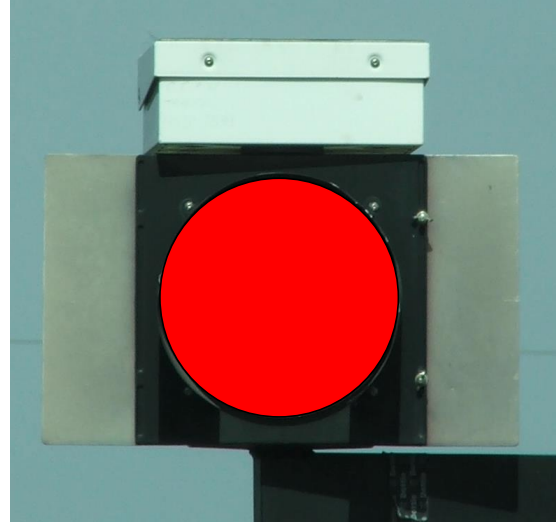
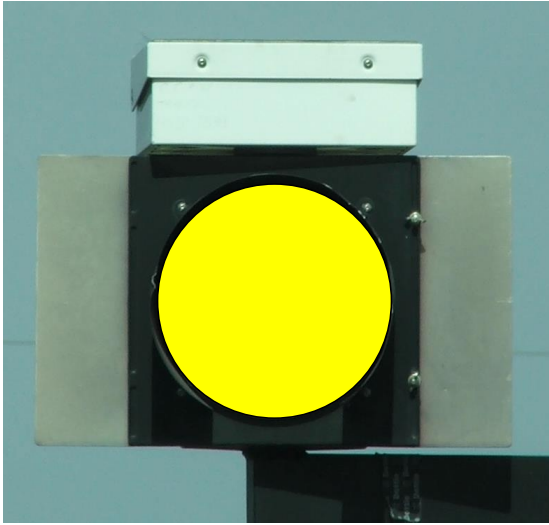

(Round Batteries)

SBI-1Y

SBI-1R

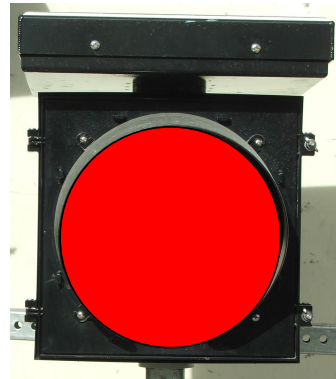
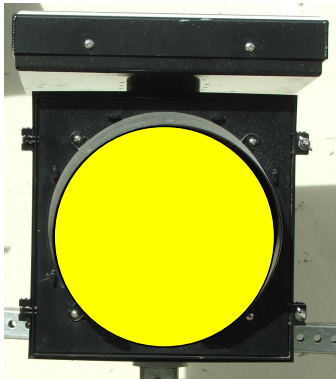

(1 Rectangular Battery)

SBI-2Y

SBI-2R

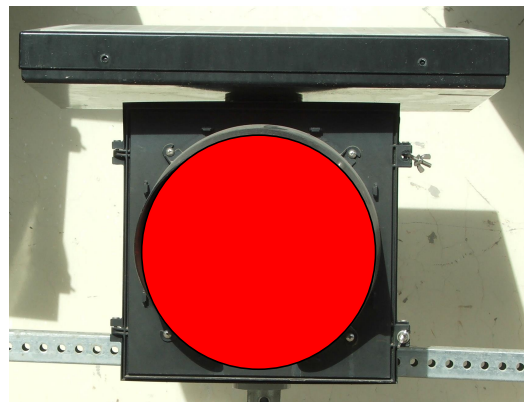
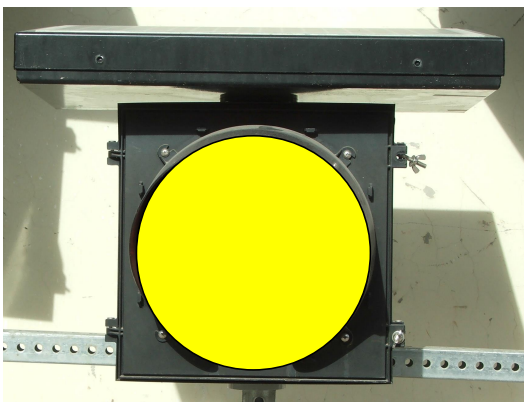

(2 Rectangular Batteries)

SBI-3Y

SBI-3R





























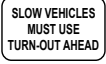











































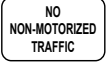

# 2B - Regulatory

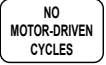

	R1-1		R2-1 25		R2-11		R3-5fP
	<b>R1-1a</b>		R2-1 30		<b>R2-90</b>		R3-5gP
	R1-2		R2-1 35		<b>R2-98</b>		<b>R3-5wP</b>
	R1-3P		R2-1 40				<b>R3-5xP</b>
	R1-2aP		R2-1 45		<b>R2-99</b>		<b>R3-5yP</b>
	R1-10P		R2-1 50				<b>R3-5zP</b>
	R1-5R		R2-1 55		R3-1		R3-8L
	R1-5L		R2-1 60		R3-2		R3-8R
	R1-5aR		R2-1 65		R3-3		R3-8aL
	R1-5aL		R2-4 25		R3-4		R3-8aR
	R1-5bR		R2-4 30		R3-18		R3-8b
	R1-5bL		R2-4 35		R3-27		<b>R3-80a</b>
	R1-5cR		R2-4 40		R3-5L		<b>R3-80b</b>
	R1-5cL		R2-4 45		R3-5R		<b>R3-80c</b>
	R1-6		R2-4 50		R3-5a		<b>R3-81a</b>
	R1-9		R2-4 55		R3-5R		<b>R3-81b</b>
			R2-6		R3-5a		<b>R3-81c</b>
			R2-6a		R3-5U		<b>R3-81d</b>
			R2-10		R3-6L		<b>R3-82a</b>
					R3-6R		<b>R3-82b</b>
					R3-7L		<b>R3-90a</b>
					R3-7R		<b>R3-90b</b>
					R3-5bP		
					R3-5eP		

\* More lane use signs in NDOT section.

# Chapter 2B Regulatory











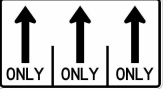

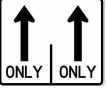
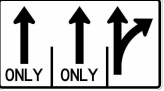



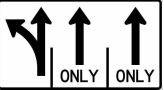
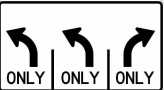

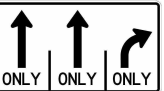
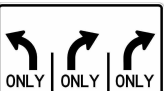

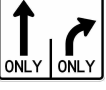
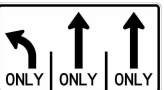

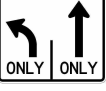





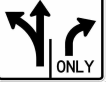
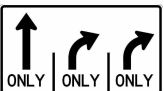

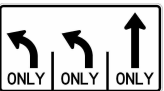

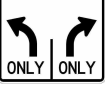
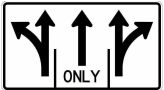

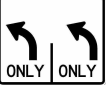
	<b>R3-91a</b>		R4-8a		R5-10c		R7-8
	<b>R3-91b</b>		R4-8b		R5-11		R7-8a
	<b>R3-11z</b>		R4-8c		<b>R5-98</b>		R7-9a
	R3-20L		R4-9		R9-3		<b>R7-94</b>
	R3-20R		R4-13		R9-14		<b>R7-94L</b>
	R3-33		R4-16		R6-1L		<b>R7-94R</b>
	R3-9a		R4-17		R6-2L		<b>R7-95</b>
	R3-9b		R4-18		R6-2R		<b>R7-95L</b>
	R3-9cP		<b>R4-99</b>		R6-3		<b>R7-95R</b>
	R3-9dP		R5-1		R6-3a		R7-107a
	R4-1		R5-1a		R6-6		R7-107aL
	R4-2		R5-2		R6-7		R7-107aR
	R4-3		R5-3		R6-4		<b>R7-240</b>
	R4-5		R5-4		R6-4a		R8-3
	R4-7		R5-6		R6-4b		R8-3cP
	R4-7a		R5-7		R6-5P		R8-3dP
	R4-7b		R5-8		R7-1a		R8-3eP
	R4-7c		R5-10a		R7-1aL		
	R4-8		R5-10b		R7-1aR		

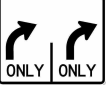

	R8-3fP		R10-3eR		R10-12		R11-1
	<b>R8-3zP</b>		R10-3eL		<b>R10-12a</b>		R11-2
	<b>R8-3zPL</b>		R10-25		<b>R10-12z</b>		R11-3a
	<b>R8-3zPR</b>		R10-5		R10-13		R11-3b
	R8-4		R10-6R		R10-14		R11-4
	R8-5		R10-6L		R10-14a		R12-1 XX
	R8-7		R10-6aR		R10-15L		R12-2 X
	R8-8		R10-6aL		R10-15R		R12-3 X
	R8-9		R10-7		R10-16		R14-1
	<b>R8-96</b>		R10-7a		R10-17a		R14-1a
	<b>R8-96P</b>		R10-10L		R10-20aP		R14-2
	R9-2		R10-10R		R10-23		R14-3
	R9-3		R10-11		R10-30		Type 3L RW
	R9-3a		R10-11a		R10-28		Type 3R RW
	R9-3bPR		R10-11b		R10-29		
	R9-3bPL		R10-11c		<b>R10-98</b>		
	R9-4		R10-11d		<b>R10-99</b>		
	R9-4a						
	<b>R9-98</b>						
	R10-1						

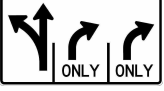

# NDOT - Regulatory

 RNV1-3	 RNV3-1	 RNV3-17	 RNV7-1
 RNV2-1	 RNV3-2	 RNV3-17a	 RNV16-1
 RNV2-2	 RNV3-3	 RNV3-18	 RNV17-1
 RNV2-3	 RNV3-4	 RNV3-19	 RNV19-1
 RNV2-4	 RNV3-5	 RNV3-20	
 RNV2-5	 RNV3-6	 RNV3-21	
 RNV2-6	 RNV3-7	 RNV3-22	
 RNV2-7	 RNV3-8	 RNV3-23	
 RNV2-8	 RNV3-9	 RNV3-24	
 RNV2-9	 RNV3-10	 RNV4-2	
*  RNV2-10	 RNV3-11		
 RNV2-11	 RNV3-12		
 RNV2-13	 RNV3-13		
 RNV2-14	 RNV3-14		
	 RNV3-15		
	 RNV3-16		

\* Standard Dual Left Turn sign for mast arm.





Table 2B-1. Regulatory Sign and Plaque Sizes (Sheet 1 of 4)

Sign or Plaque	Sign Designation	Section	Conventional Road		Expressway	Freeway	Minimum	Oversized
			Single Lane	Multi-Lane				
Stop	R1-1	2B.05	30 x 30*	36 x 36	36 x 36	—	30 x 30*	48 x 48
Yield	R1-2	2B.08	36x36x36*	48x48x48	48x48x48	60x60x60	30x30x30*	—
To Oncoming Traffic (plaque)	R1-2aP	2B.10	24 x 18	24 x 18	36 x 30	48 x 36	24 x 18	—
All Way (plaque)	R1-3P	2B.05	18 x 6	18 x 6	—	—	—	30 x 12
Yield Here to Peds	R1-5	2B.11	—	36 x 36	—	—	—	36 x 36
Yield Here to Pedestrians	R1-5a	2B.11	—	36 x 48	—	—	—	36 x 48
Stop Here for Peds	R1-5b	2B.11	—	36 x 36	—	—	—	36 x 36
Stop Here for Pedestrians	R1-5c	2B.11	—	36 x 48	—	—	—	36 x 48
In-Street Ped Crossing	R1-6,6a	2B.12	12 x 36	12 x 36	—	—	—	—
Overhead Ped Crossing	R1-9,9a	2B.12	90 x 24	90 x 24	—	—	—	—
Except Right Turn (plaque)	R1-10P	2B.05	24 x 18	24 x 18	—	—	—	—
Speed Limit	R2-1	2B.13	24 x 30*	30 x 36	36 x 48	48 x 60	18 x 24*	30 x 36
Truck Speed Limit (plaque)	R2-2P	2B.14	24 x 24	24 x 24	36 x 36	48 x 48	—	36 x 36
Night Speed Limit (plaque)	R2-3P	2B.15	24 x 24	24 x 24	36 x 36	48 x 48	—	36 x 36
Minimum Speed Limit (plaque)	R2-4P	2B.16	24 x 30	24 x 30	36 x 48	48 x 60	—	36 x 48
Combined Speed Limit	R2-4a	2B.16	24 x 48	24 x 48	36 x 72	48 x 96	—	36 x 72
Unless Otherwise Posted (plaque)	R2-5P	2B.13	24 x 18	24 x 18	—	—	—	—
Citywide (plaque)	R2-5aP	2B.13	24 x 6	24 x 6	—	—	—	—
Neighborhood (plaque)	R2-5bP	2B.13	24 x 6	24 x 6	—	—	—	—
Residential (plaque)	R2-5cP	2B.13	24 x 6	24 x 6	—	—	—	—
Fines Higher (plaque)	R2-6P	2B.17	24 x 18	24 x 18	36 x 24	48 x 36	—	36 x 24
Fines Double (plaque)	R2-6aP	2B.17	24 x 18	24 x 18	36 x 24	48 x 36	—	36 x 24
\$XX Fine (plaque)	R2-6bP	2B.17	24 x 18	24 x 18	36 x 24	48 x 36	—	36 x 24
Begin Higher Fines Zone	R2-10	2B.17	24 x 30	24 x 30	36 x 48	48 x 60	—	36 x 48
End Higher Fines Zone	R2-11	2B.17	24 x 30	24 x 30	36 x 48	48 x 60	—	36 x 48
Movement Prohibition	R3-1,2,3,4,18,27	2B.18	24 x 24*	36 x 36	36 x 36	—	—	48 x 48
Mandatory Movement Lane Control	R3-5,5a	2B.20	30 x 36	30 x 36	—	—	—	—
Left Lane (plaque)	R3-5bP	2B.20	30 x 12	30 x 12	—	—	—	—
HOV 2+ (plaque)	R3-5cP	2B.20	24 x 12	24 x 12	—	—	—	—
Taxi Lane (plaque)	R3-5dP	2B.20	30 x 12	30 x 12	—	—	—	—
Center Lane (plaque)	R3-5eP	2B.20	30 x 12	30 x 12	—	—	—	—
Right Lane (plaque)	R3-5fP	2B.20	30 x 12	30 x 12	—	—	—	—
Bus Lane (plaque)	R3-5gP	2B.20	30 x 12	30 x 12	—	—	—	—
Optional Movement Lane Control	R3-6	2B.21	30 x 36	30 x 36	—	—	—	—
Right (Left) Lane Must Turn Right (Left)	R3-7	2B.20	30 x 30*	36 x 36	—	—	—	—
Advance Intersection Lane Control	R3-8,8a,8b	2B.22	Varies x 30	Varies x 30	—	—	—	Varies x 36
Two-Way Left Turn Only (overhead)	R3-9a	2B.24	30 x 36	30 x 36	—	—	—	—
Two-Way Left Turn Only (post-mounted)	R3-9b	2B.24	24 x 36	24 x 36	—	—	—	36 x 48
BEGIN	R3-9cP	2B.25	30 x 12	30 x 12	—	—	—	—
END	R3-9dP	2B.25	30 x 12	30 x 12	—	—	—	—
Reversible Lane Control (symbol)	R3-9e	2B.26	108 x 48	108 x 48	—	—	—	—
Reversible Lane Control (post-mounted)	R3-9f	2B.26	30 x 42*	36 x 54	—	—	—	—
Advance Reversible Lane Control Transition Signing	R3-9g,9h	2B.26	108 x 36	108 x 36	—	—	—	—
End Reverse Lane	R3-9i	2B.26	108 x 48	108 x 48	—	—	—	—
Begin Right (Left) Turn Lane	R3-20	2B.20	24 x 36	24 x 36	—	—	—	—
All Turns (U Turn) from Right Lane	R3-23,23a	2B.27	60 x 36	60 x 36	—	—	—	—
All Turns (U Turn) with arrow	R3-24,24b,25,25b,26a	2B.27	72 x 18	72 x 18	—	—	—	—
U and Left Turns with arrow	R3-24a,25a,26	2B.27	60 x 24	60 x 24	—	—	—	—
Right Lane Must Exit	R3-33	2B.23	—	—	78 x 36	78 x 36	—	—



**Table 2B-1. Regulatory Sign and Plaque Sizes (Sheet 2 of 4)**

Sign or Plaque	Sign Designation	Section	Conventional Road		Expressway	Freeway	Minimum	Oversized
			Single Lane	Multi-Lane				
Do Not Pass	R4-1	2B.28	24 x 30	24 x 30	36 x 48	48 x 60	18 x 24	36 x 48
Pass With Care	R4-2	2B.29	24 x 30	24 x 30	36 x 48	48 x 60	18 x 24	36 x 48
Slower Traffic Keep Right	R4-3	2B.30	24 x 30	24 x 30	36 x 48	48 x 60	18 x 24	36 x 48
Trucks Use Right Lane	R4-5	2B.31	24 x 30	24 x 30	36 x 48	48 x 60	—	36 x 48
Keep Right	R4-7,7a,7b	2B.32	24 x 30	24 x 30	36 x 48	48 x 60	18 x 24	36 x 48
Narrow Keep Right	R4-7c	2B.32	18 x 30	18 x 30	—	—	—	—
Keep Left	R4-8,8a,8b	2B.32	24 x 30	24 x 30	36 x 48	48 x 60	18 x 24	36 x 48
Narrow Keep Left	R4-8c	2B.32	18 x 30	18 x 30	—	—	—	—
Stay in Lane	R4-9	2B.33	24 x 30	24 x 30	36 x 48	48 x 60	18 x 24	36 x 48
Runaway Vehicles Only	R4-10	2B.34	48 x 48	48 x 48	—	—	—	—
Slow Vehicles with XX or More Following Vehicles Must Use Turn-Out	R4-12	2B.35	42 x 24	42 x 24	—	—	—	—
Slow Vehicles Must Use Turn-Out Ahead	R4-13	2B.35	42 x 24	42 x 24	—	—	—	—
Slow Vehicles Must Turn Out	R4-14	2B.35	30 x 42	30 x 42	—	—	—	—
Keep Right Except to Pass	R4-16	2B.30	24 x 30	24 x 30	36 x 48	48 x 60	18 x 24	36 x 48
Do Not Drive on Shoulder	R4-17	2B.36	24 x 30	24 x 30	36 x 48	48 x 60	18 x 24	36 x 48
Do Not Pass on Shoulder	R4-18	2B.36	24 x 30	24 x 30	36 x 48	48 x 60	18 x 24	36 x 48
Do Not Enter	R5-1	2B.37	30 x 30*	36 x 36	36 x 36	48 x 48	—	36 x 36
Wrong Way	R5-1a	2B.38	36 x 24*	42 x 30	36 x 24*	42 x 30	30 x 18*	42 x 30
No Trucks	R5-2,2a	2B.39	24 x 24	24 x 24	30 x 30	36 x 36	—	36 x 36
No Motor Vehicles	R5-3	2B.39	24 x 24	24 x 24	—	—	24 x 24	—
No Commercial Vehicles	R5-4	2B.39	24 x 30	24 x 30	36 x 48	36 x 48	—	—
No Vehicles with Lugs	R5-5	2B.39	24 x 30	24 x 30	36 x 48	48 x 60	—	—
No Bicycles	R5-6	2B.39	24 x 24	24 x 24	30 x 30	36 x 36	24 x 24	48 x 48
No Non-Motorized Traffic	R5-7	2B.39	30 x 24	30 x 24	42 x 24	48 x 30	—	42 x 24
No Motor-Driven Cycles	R5-8	2B.39	30 x 24	30 x 24	42 x 24	48 x 30	—	42 x 24
No Pedestrians, Bicycles, Motor-Driven Cycles	R5-10a	2B.39	30 x 36	30 x 36	—	—	—	—
No Pedestrians or Bicycles	R5-10b	2B.39	30 x 18	30 x 18	—	—	—	—
No Pedestrians	R5-10c	2B.39	24 x 12	24 x 12	—	—	—	—
Authorized Vehicles Only	R5-11	2B.39	30 x 24	30 x 24	—	—	—	—
One Way	R6-1	2B.40	36 x 12*	54 x 18	54 x 18	54 x 18	—	54 x 18
One Way	R6-2	2B.40	24 x 30*	30 x 36	36 x 48	48 x 60	18 x 24*	36 x 48
Divided Highway Crossing	R6-3,3a	2B.42	30 x 24	30 x 24	36 x 30	—	—	36 x 30
Roundabout Directional (2 chevrons)	R6-4	2B.43	30 x 24	30 x 24	—	—	—	—
Roundabout Directional (3 chevrons)	R6-4a	2B.43	48 x 24	48 x 24	—	—	—	—
Roundabout Directional (4 chevrons)	R6-4b	2B.43	60 x 24	60 x 24	—	—	—	—
Roundabout Circulation (plaque)	R6-5P	2B.44	30 x 30	30 x 30	—	—	—	—
BEGIN ONE WAY	R6-6	2B.40	24 x 30	30 x 36	—	—	—	—
END ONE WAY	R6-7	2B.40	24 x 30	30 x 36	—	—	—	—
Parking Restrictions	R7-1, 2,2a,3,4,5,6,7,8, 21,21a,22,23, 23a,107,108	2B.46	12 x 18	12 x 18	—	—	—	—
Van Accessible (plaque)	R7-8P	2B.46	18 x 9	18 x 9	—	—	—	—
Fee Station	R7-20	2B.46	24 x 18	24 x 18	—	—	—	—
No Parking (with transit logo)	R7-107a	2B.46	12 x 30	12 x 30	—	—	—	—
No Parking/Restricted Parking (combined sign)	R7-200	2B.46	24 x 18	24 x 18	—	—	—	—
No Parking/Restricted Parking (combined sign)	R7-200a	2B.46	12 x 30	12 x 30	—	—	—	—
Tow Away Zone (plaque)	R7-201P,201aP	2B.46	12 x 6	12 x 6	—	—	—	—
This Side of Sign (plaque)	R7-202P	2B.46	12 x 6	12 x 6	—	—	—	—



**Table 2B-1. Regulatory Sign and Plaque Sizes (Sheet 3 of 4)**

Sign or Plaque	Sign Designation	Section	Conventional Road		Expressway	Freeway	Minimum	Oversized
			Single Lane	Multi-Lane				
Emergency Snow Route	R7-203	2B.46	18 x 24	18 x 24	—	—	—	24 x 30
No Parking on Pavement	R8-1	2B.46	24 x 30	24 x 30	36 x 48	48 x 60	—	36 x 48
No Parking Except on Shoulder	R8-2	2B.46	24 x 30	24 x 30	36 x 48	48 x 60	—	36 x 48
No Parking (symbol)	R8-3	2B.46	24 x 24*	30 x 30	36 x 36	48 x 48	12 x 12*	36 x 36
No Parking	R8-3a	2B.46	24 x 30	24 x 30	36 x 36	48 x 48	18 x 24	36 x 36
Except Sundays and Holidays (plaque)	R8-3bP	2B.46	24 x 18	24 x 18	—	—	12 x 9	30 x 24
On Pavement (plaque)	R8-3cP	2B.46	24 x 18	24 x 18	—	—	12 x 9	30 x 24
On Bridge (plaque)	R8-3dP	2B.46	24 x 18	24 x 18	—	—	12 x 9	30 x 24
On Tracks (plaque)	R8-3eP	2B.46	12 x 9	12 x 9	—	—	—	30 x 24
Except on Shoulder (plaque)	R8-3fP	2B.46	24 x 18	24 x 18	—	—	12 x 9	30 x 24
Loading Zone (plaque)	R8-3gP	2B.46	24 x 18	24 x 18	—	—	12 x 9	30 x 24
Times of Day (plaque)	R8-3hP	2B.46	24 x 18	24 x 18	—	—	12 x 9	30 x 24
Emergency Parking Only	R8-4	2B.49	30 x 24	30 x 24	30 x 24	48 x 36	—	48 x 36
No Stopping on Pavement	R8-5	2B.46	24 x 30	24 x 30	36 x 48	48 x 60	—	36 x 48
No Stopping Except on Shoulder	R8-6	2B.46	24 x 30	24 x 30	36 x 48	48 x 60	—	36 x 48
Emergency Stopping Only	R8-7	2B.49	30 x 24	30 x 24	48 x 36	48 x 36	—	48 x 36
Walk on Left Facing Traffic	R9-1	2B.50	18 x 24	18 x 24	—	—	—	—
Cross Only at Crosswalks	R9-2	2B.51	12 x 18	12 x 18	—	—	—	—
No Pedestrian Crossing (symbol)	R9-3	2B.51	18 x 18	18 x 18	24 x 24	30 x 30	—	30 x 30
No Pedestrian Crossing	R9-3a	2B.51	12 x 18	12 x 18	—	—	—	—
Use Crosswalk (plaque)	R9-3bP	2B.51	18 x 12	18 x 12	—	—	—	—
No Hitchhiking (symbol)	R9-4	2B.50	18 x 18	18 x 18	—	—	—	24 x 24
No Hitchhiking	R9-4a	2B.50	18 x 24	18 x 24	—	—	12 x 18	—
No Skaters	R9-13	2B.39	18 x 18	18 x 18	24 x 24	30 x 30	—	30 x 30
No Equestrians	R9-14	2B.39	18 x 18	18 x 18	24 x 24	30 x 30	—	30 x 30
Cross Only On Green	R10-1	2B.52	12 x 18	12 x 18	—	—	—	—
Pedestrian Signs and Plaques	R10-2, 3,3b,3c,3d,4	2B.52	9 x 12	9 x 12	—	—	—	—
Pedestrian Signs	R10-3a,3e,3f, 3g,3h,3i,4a	2B.52	9 x 15	9 x 15	—	—	—	—
Left on Green Arrow Only	R10-5	2B.53	30 x 36	30 x 36	48 x 60	—	24 x 30	48 x 60
Stop Here on Red	R10-6	2B.53	24 x 36	24 x 36	—	—	—	36 x 48
Stop Here on Red	R10-6a	2B.53	24 x 30	24 x 30	—	—	—	36 x 42
Do Not Block Intersection	R10-7	2B.53	24 x 30	24 x 30	—	—	—	—
Use Lane with Green Arrow	R10-8	2B.53	36 x 42	36 x 42	36 x 42	—	—	60 x 72
Left (Right) Turn Signal	R10-10	2B.53	30 x 36	30 x 36	—	—	—	—
No Turn on Red	R10-11	2B.54	24 x 30*	36 x 48	—	—	—	36 x 48
No Turn on Red	R10-11a	2B.54	30 x 36*	36 x 48	—	—	—	—
No Turn on Red	R10-11b	2B.54	36 x 36	36 x 36	—	—	—	—
No Turn on Red Except From Right Lane	R10-11c	2B.54	30 x 42	30 x 42	—	—	—	—
No Turn on Red From This Lane	R10-11d	2B.54	30 x 42	30 x 42	—	—	—	—
Left Turn Yield on Green	R10-12	2B.53	30 x 36	30 x 36	—	—	—	—
Emergency Signal	R10-13	2B.53	42 x 30	42 x 30	—	—	—	—
Emergency Signal - Stop on Flashing Red	R10-14	2B.53	36 x 42	36 x 42	—	—	—	—
Emergency Signal - Stop on Flashing Red (overhead)	R10-14a	2B.53	60 x 24	60 x 24	—	—	—	—
Turning Vehicles Yield to Peds	R10-15	2B.53	30 x 30	30 x 30	—	—	—	—
U-Turn Yield to Right Turn	R10-16	2B.53	30 x 36	30 x 36	—	—	—	—
Right on Red Arrow After Stop	R10-17a	2B.54	36 x 48	36 x 48	—	—	—	—
Traffic Laws Photo Enforced	R10-18	2B.55	36 x 24	36 x 24	48 x 30	54 x 36	—	54 x 36
Photo Enforced (symbol plaque)	R10-19P	2B.55	24 x 12	24 x 12	36 x 18	48 x 24	—	48 x 24
Photo Enforced (plaque)	R10-19aP	2B.55	24 x 18	24 x 18	36 x 30	48 x 36	—	48 x 36
MON—FRI (and times) (3 lines) (plaque)	R10-20aP	2B.53	24 x 24	24 x 24	—	—	—	—





**Table 2B-1. Regulatory Sign and Plaque Sizes (Sheet 4 of 4)**

Sign or Plaque	Sign Designation	Section	Conventional Road		Expressway	Freeway	Minimum	Oversized
			Single Lane	Multi-Lane				
SUNDAY (and times) (2 lines) (plaque)	R10-20aP	2B.53	24 x 18	24 x 18	—	—	—	—
Crosswalk, Stop on Red	R10-23	2B.53	24 x 30	24 x 30	—	—	—	—
Push Button To Turn On Warning Lights	R10-25	2B.52	9 x 12	9 x 12	—	—	—	—
Left Turn Yield on Flashing Red Arrow After Stop	R10-27	2B.53	30 x 36	30 x 36	—	—	—	—
XX Vehicles Per Green	R10-28	2B.56	24 x 30	24 x 30	—	—	—	—
XX Vehicles Per Green Each Lane	R10-29	2B.56	36 x 24	36 x 24	—	—	—	—
Right Turn on Red Must Yield to U-Turn	R10-30	2B.54	30 x 36	30 x 36	—	—	—	—
At Signal (plaque)	R10-31P	2B.53	24 x 9	24 x 9	—	—	—	—
Push Button for 2 Seconds for Extra Crossing Time	R10-32P	2B.52	9 x 12	9 x 12	—	—	—	—
Keep Off Median	R11-1	2B.57	24 x 30	24 x 30	—	—	—	—
Road Closed	R11-2	2B.58	48 x 30	48 x 30	—	—	—	—
Road Closed - Local Traffic Only	R11-3a,3b,4	2B.58	60 x 30	60 x 30	—	—	—	—
Weight Limit	R12-1,2	2B.59	24 x 30	24 x 30	36 x 48	—	—	36 x 48
Weight Limit	R12-3	2B.59	24 x 36	24 x 36	—	—	—	—
Weight Limit	R12-4	2B.59	36 x 24	36 x 24	—	—	—	—
Weight Limit	R12-5	2B.59	24 x 36	24 x 36	36 x 48	48 x 60	—	—
Weigh Station	R13-1	2B.60	72 x 54	72 x 54	96 x 72	120 x 90	—	—
Truck Route	R14-1	2B.61	24 x 18	24 x 18	—	—	—	—
Hazardous Material	R14-2,3	2B.62	24 x 24	24 x 24	30 x 30	36 x 36	—	42 x 42
National Network	R14-4,5	2B.63	30 x 30	30 x 30	36 x 36	36 x 36	—	42 x 42
Fender Bender Move Vehicles	R16-4	2B.65	36 x 24	36 x 24	48 x 36	60 x 48	—	48 x 36
Lights On When Using Wipers or Raining	R16-5,6	2B.64	24 x 30	24 x 30	36 x 48	48 x 60	—	36 x 48
Turn On Headlights Next XX Miles	R16-7	2B.64	48 x 15	48 x 15	72 x 24	96 x 30	—	72 x 24
Turn On, Check Headlights	R16-8,9	2B.64	30 x 15	30 x 15	48 x 24	60 x 30	—	48 x 24
Begin, End Daytime Headlight Section	R16-10,11	2B.64	48 x 15	48 x 15	72 x 24	96 x 30	—	72 x 24

\* See Table 9B-1 for minimum size required for signs on bicycle facilities

- Notes: 1. Larger signs may be used when appropriate  
 2. Dimensions in inches are shown as width x height

07 **Where side roads intersect a multi-lane street or highway that has a speed limit of 45 mph or higher, the minimum size of the STOP signs facing the side road approaches, even if the side road only has one approach lane, shall be 36 x 36 inches.**

08 **Where side roads intersect a multi-lane street or highway that has a speed limit of 40 MPH or lower, the minimum size of the STOP signs facing the side road approaches shall be as shown in the Single Lane or Multi-lane columns of Table 2B-1 based on the number of approach lanes on the side street approach.**

*Guidance:*

09 *The minimum sizes for regulatory signs facing traffic on exit and entrance ramps should be as shown in the column of Table 2B-1 that corresponds to the mainline roadway classification (Expressway or Freeway). If a minimum size is not provided in the Freeway column, the minimum size in the Expressway column should be used. If a minimum size is not provided in the Freeway or Expressway Column, the size in the Oversized column should be used.*

**Section 2B.04 Right-of-Way at Intersections**

Support:

01 State or local laws written in accordance with the “Uniform Vehicle Code” (see Section 1A.11) establish the right-of-way rule at intersections having no regulatory traffic control signs such that the driver of a vehicle approaching an intersection must yield the right-of-way to any vehicle or pedestrian already in the intersection.



# NDOT Sign Sizes

Type	Code	W	H	Type	Code	W	H
RNV	1 - 1	30	x 36	RNV	6 - 2	96	x 48
RNV	1 - 2	30	x 36	RNV	6 - 2	132	x 66
RNV	1 - 3	30	x 36	RNV	6 - 3	42	x 30
RNV	2 - 1	36	x 30	RNV	6 - 3	54	x 36
RNV	2 - 2	36	x 30	RNV	6 - 4	48	x 30
RNV	2 - 3	36	x 30	RNV	6 - 4	54	x 36
RNV	2 - 4	36	x 30	RNV	7 - 1	72	x 48
RNV	2 - 5	36	x 30	RNV	7 - 2	72	x 54
RNV	2 - 6	36	x 30	RNV	7 - 3	84	x 72
RNV	2 - 7	36	x 30	RNV	7 - 4	60	x 48
RNV	2 - 8	36	x 30	RNV	8 - 1	108	x 36
RNV	2 - 9	36	x 30	RNV	8 - 2	108	x 36
RNV	2 - 10	36	x 30	RNV	8 - 3	108	x 36
RNV	2 - 11	36	x 30	RNV	8 - 4	66	x 36
RNV	2 - 12	36	x 30	RNV	9 - 1	96	x 54
RNV	2 - 13	42	x 30	RNV	9 - 1	126	x 72
RNV	2 - 14	42	x 30	RNV	9 - 1	216	x 108
RNV	3 - 1	54	x 30	RNV	9 - 2	42	x 30
RNV	3 - 2	54	x 30	RNV	9 - 3	54	x 30
RNV	3 - 3	54	x 30	RNV	9 - 4	42	x 36
RNV	3 - 4	54	x 30	RNV	10 - 1	V	x 24
RNV	3 - 5	54	x 30	RNV	11 - 1	102	x 48
RNV	3 - 6	54	x 30	RNV	11 - 1	138	x 66
RNV	3 - 7	54	x 30	RNV	11 - 1	210	x 96
RNV	3 - 8	54	x 30	RNV	12 - 1	114	x 42
RNV	3 - 9	54	x 30	RNV	12 - 1	150	x 48
RNV	3 - 10	54	x 30	RNV	13 - 1	144	x 78
RNV	3 - 11	54	x 30	RNV	14 - 1	V	x 24
RNV	3 - 12	54	x 30	RNV	15 - 1	84	x 48
RNV	3 - 13	54	x 30	RNV	16 - 1	36	x 42
RNV	3 - 14	54	x 30	RNV	16 - 1	48	x 54
RNV	3 - 15	54	x 30	RNV	17 - 1	24	x 18
RNV	3 - 16	54	x 30	RNV	18 - 1	30	x 18
RNV	3 - 17	54	x 30	RNV	18 - 1	42	x 24
RNV	3 - 18	54	x 30	RNV	19 - 1	54	x 36
RNV	3 - 19	54	x 30	RNV	20 - 1	48	x 36
RNV	3 - 20	54	x 30	RNV	20 - 1	72	x 48
RNV	3 - 21	54	x 30	RNV	21 - 1	42	x 36
RNV	3 - 22	54	x 30	RNV	22 - 1	78	x 42
RNV	3 - 23	54	x 30	RNV	22 - 1	138	x 54
RNV	3 - 24	54	x 30	RNV	23 - 1	24	x 30
RNV	4 - 1	66	x 54	RNV	24 - 1	30	x 36
RNV	4 - 2	84	x 54	RNV	25 - 1	12	x 18
RNV	5 - 1	60	x 42	RNV	26 - 1	12	x 18
RNV	6 - 1	54	x 48	RNV	27 - 1	24	x 36
RNV	6 - 1	72	x 66	RNV	27 - 2	42	x 36



































































# NDOT Sign Sizes

Type	Code	W	H
RNV	28 - 1	96	x 66
RNV	29 - 1	60	x 24
RNV	30 - 1	60	x 36
RNV	30 - 2	42	x 36
RNV	31 - 1	60	x 18
RNV	31 - 1	120	x 36
RNV	31 - 2	48	x 36
RNV	31 - 3	48	x 36
RNV	31 - 4	30	x 30















































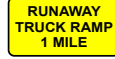

























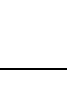

# 2C - Warning











































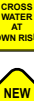

















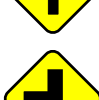







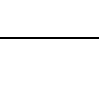

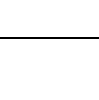
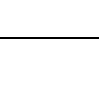





















































	* W1-1L		W1-2aL 45		W1-6		W1-10dRL
	* W1-1R		W1-2aL 50		W1-7		W1-10dRR
	* W1-1aL 10		W1-2aL 55		W1-8		W1-10eL
	* W1-1aL 15		W1-2aL 60		W1-10LL		W1-10eR
	* W1-1aL 20		W1-2aR 35		W1-10LR		W1-11L
	W1-1aL 25		W1-2aR 40		W1-10RL		W1-11R
	* W1-1aL 30		W1-2aR 45		W1-10RR		W1-13L
	* W1-1aR 10		W1-2aR 50		W1-10aL		W1-13R
	* W1-1aR 15		W1-2aR 55		W1-10aR		W1-15L
	* W1-1aR 20		W1-2aR 60		W1-10bL		W1-15R
	* W1-1aR 25		* W1-3L		W1-10bR		W13-1P 10
	* W1-1aR 30		* W1-3R		W1-10cL		W13-1P 15
	W1-2L		W1-4L		W1-10cR		W13-1P 20
	W1-2R		W1-4R		W1-10dLL		W13-1P 25
	W1-2aL 35		W1-5L		W1-10dLR		W13-1P 30
	W1-2aL 40		W1-5R				W13-1P 35
							W13-1P 40
							W13-1P 45

\* Advisory Speed of  
30 MPH or less



	W13-1P 50		W13-6 25		W13-7 60		W12-2a (XY)
	W13-1P 55		W13-6 30		W7-1		W14-1
	W13-1P 60		W13-6 35		W7-1a (G)		W14-1aL
	W13-2 25		W13-6 40		W7-2P		W14-1aR
	W13-2 30		W13-6 45		W7-2bP		W14-2
	W13-2 35		W13-6 50		W7-3P (G)		W14-2aL
	W13-2 40		W13-6 55		W7-3aP (X)		W14-2aR
	W13-2 45		W13-6 60		W7-3bP (G)(X)		W19-1
	W13-2 50		W13-6 65		W7-4		W19-2
	W13-2 55		W13-6 70		W7-4b		W19-3
	W13-2 60		W13-6 75		W7-4c		<b>W19-3a</b>
	W13-2 65		W13-6 80		W7-6		<b>W19-3b</b>
	W13-2 70		W13-6 85		W5-1		W19-4
	W13-2 75		W13-6 90		W5-2		W3-1
	W13-2 80		W13-6 95		W5-3		W3-2
	W13-2 85		W13-6 100		W6-1		W3-3
	W13-2 90				W6-2		W3-4
	W13-2 95				W12-1		W3-4a
	W13-2 100				W12-2 (XY)		W3-7
							W3-8

	W8-1		W8-17L		W3-5 40		W4-6R
	W8-2		W8-18		W3-5 45		W4-7L
	W8-2a		W8-19		W3-5 50		W4-7R
	W8-3		W8-21		W3-5 55		W6-3
	W8-4		W8-22		W3-5 60		W9-1L
	W8-5P		W8-23		W3-5 65		W9-1R
	W8-5aP		W8-25		W4-1L		W9-2L
	W8-5bP		<b>W8-97</b>		W4-1R		W9-2R
	W8-5cP		<b>W8-98P</b>		W4-2L		W9-7
	W8-7		W23-2		W4-2R		<b>W9-99L</b>
	W8-8		W23-2a		W4-3L		<b>W9-99R</b>
	W8-9		<b>W23-98</b>		W4-3R		W14-3
	W8-14		<b>W23-99</b>		W4-5L		W1-7
	W8-15		W3-5 25		W4-5R		W2-1
	W8-15aP		W3-5 30		W4-5P		W2-2
	W8-16		W3-5 35		W4-6L		W2-3L
	W8-17R						

	W2-3R		W11-8L		W11-19		W16-15P
	W2-4		W11-8R		W11-22		W20-3 Y
	W2-5		W11-10		W15-1		W20-3 Y 5
	W2-6		W11-11		W16-1		
	W16-17P		W11-12P		W16-1P		
	W16-12P		W11-14		W16-2P (XXX)		
	W2-7L		W11-15		W16-2aP (XXX)		
	W2-7R		W11-15P		W16-3P (X)		
	W2-8		W11-15a		W16-3aP (X)		
	W2-97		W11-2L		W16-4P (XXX)		
	W4-4P		W11-2R		W16-5P		
	W4-4aP		W11-3		W16-6pL		
	W4-4bP		W11-4		W16-6pR		
	W4-4cP		W11-7		W16-7PL		
	W8-6		W11-9		W16-7PL YG		
	W11-1		W11-18		W16-7PR		
	W11-5				W16-7PR YG		
	W11-5a				W16-8P		
					W16-8aP		
					W16-9P		
					W16-9P YG		
					W16-13P		



K-71 YY



K-71 WW

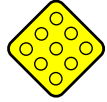

OM1-1

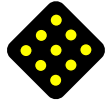

OM1-2



OM1-3

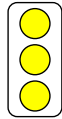

OM2-1V



OM2-2V

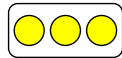

OM2-1H



OM2-2H



OM3-L



OM3-C



OM3-R

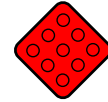

OM4-1

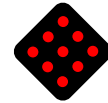

OM4-2



OM4-3



NDOT - Warning



WNV2-1



WNV4-1



WNV9-1



WNV10-1



WNV11-1



WNV12-1



WNV15-1



WNV15-8



WNV18-1



WNV19-2L



WNV19-2R



**Table 2C-1. Categories of Warning Signs and Plaques**

Category	Group	Section	Signs or Plaques	Sign Designations	
Roadway Related	Changes in Horizontal Alignment	2C.07	Turn, Curve, Reverse Turn, Reverse Curve, Winding Road, Hairpin Curve, 270-Degree Curve	W1-1,2,3,4,5,11,15	
		2C.08	Advisory Speed	W13-1P	
		2C.09	Chevron Alignment	W1-8	
		2C.10	Combination Horizontal Alignment/Advisory Speed	W1-1a,2a	
		2C.11	Combination Horizontal Alignment/Intersection	W1-10,10a,10b,10c,10d	
		2C.12	Large Arrow (one direction)	W1-6	
		2C.13	Truck Rollover	W1-13	
		2C.14	Advisory Exit or Ramp Speed	W13-2,3	
	Vertical Alignment	2C.15	Combination Horizontal Alignment/Advisory Exit or Ramp Speed	W13-6,7	
		2C.16	Hill	W7-1,1a,2P,2bP,3P,3aP,3bP	
		2C.17	Truck Escape Ramp	W7-4,4b,4c,4dP,4eP,4fP	
	Cross Section	2C.18	Hill Blocks View	W7-6	
		2C.19	Road Narrows	W5-1	
		2C.20,21	Narrow Bridge, One Lane Bridge	W5-2,3	
		2C.22,23,25	Divided Highway, Divided Highway Ends, Double Arrow	W6-1,2; W12-1	
		2C.24	Freeway or Expressway Ends, All Traffic Must Exit	W19-1,2,3,4,5	
		2C.26	Dead End, No Outlet	W14-1,1a,2,2a	
		2C.27	Low Clearance	W12-2,2a	
		Roadway Surface Condition	2C.28,29	Bump, Dip, Speed Hump	W8-1,2; W17-1
	2C.30		Pavement Ends	W8-3	
	2C.31		Shoulder, Uneven Lanes	W8-4,9,11,17,17P,23,25	
	2C.32		Slippery When Wet, Loose Gravel, Rough Road, Bridge Ices Before Road, Fallen Rocks	W8-5,7,8,13,14	
	2C.33		Grooved Pavement, Metal Bridge Deck	W8-15,15P,16	
	Weather	2C.34	No Center Line	W8-12	
		2C.35	Road May Flood, Flood Gauge, Gusty Winds Area, Fog Area	W8-18,19,21,22	
	Traffic Related	Advance Traffic Control	2C.36-39	Stop Ahead, Yield Ahead, Signal Ahead, Be Prepared To Stop, Speed Reduction, Drawbridge Ahead, Ramp Meter Ahead	W3-1,2,3,4,5,5a,6,7,8
		Traffic Flow	2C.40-45	Merge, No Merge Area, Lane Ends, Added Lane, Two-Way Traffic, Right Lane Exit Only Ahead, No Passing Zone	W4-1,2,3,5,5P,6; W6-3; W9-1,2,7; W14-3
		Intersections	2C.46	Cross Road, Side Road, T, Y, Circular Intersection, Side Roads	W2-1,2,3,4,5,6,7,8; W16-12P,17P
			2C.47	Large Arrow (two directions)	W1-7
			2C.48	Oncoming Extended Green	W25-1,2
		Vehicular Traffic	2C.49	Truck Crossing, Truck (symbol), Emergency Vehicle, Tractor, Bicycle, Golf Cart, Horse-Drawn Vehicle, Trail Crossing	W8-6; W11-1,5,5a,8,10,11,12P,14,15,15P,15a; W16-13P
		Non-Vehicular	2C.50,51	Pedestrian, Deer, Cattle, Snowmobile, Equestrian, Wheelchair, Large Animals, Playground	W11-2,3,4,6,7,9,16,17,18,19,20,21,22; W15-1; W16-13P
	New	2C.52	New Traffic Pattern Ahead	W23-2	
	Other Supplemental Plaques	Location	2C.53	Downward Diagonal Arrow, Ahead	W16-7P,9P
		HOV	2C.53	High-Occupancy Vehicle	W16-11P
Distance		2C.55	XX Feet, XX Miles, Next XX Feet, Next XX Miles	W7-3aP; W16-2P,2aP,3P,3aP,4P	
Arrow		2C.56	Advance Arrow, Directional Arrow	W16-5P,6P	
Street Name Plaque		2C.58	Advance Street Name	W16-8P,8aP	
Intersection		2C.59	Cross Traffic Does Not Stop	W4-4P,4aP,4bP	
Share The Road		2C.60	Share The Road	W16-1P	
Photo Enforced		2C.61	Photo Enforced	W16-10P,10aP	
New	2C.62	New	W16-15P		





Table 2C-2. Warning Sign and Plaque Sizes (Sheet 1 of 3)

Sign or Plaque	Sign Designation	Section	Conventional Road		Expressway	Freeway	Minimum	Oversized
			Single Lane	Multi-Lane				
Horizontal Alignment	W1-1,2,3,4,5	2C.07	30 x 30*	36 x 36	36 x 36	36 x 36	—	48 x 48
Combination Horizontal Alignment/Advisory Speed	W1-1a,2a	2C.10	36 x 36	36 x 36	48 x 48	48 x 48	—	48 x 48
One-Direction Large Arrow	W1-6	2C.12	48 x 24	48 x 24	60 x 30	60 x 30	—	60 x 30
Two-Direction Large Arrow	W1-7	2C.47	48 x 24	48 x 24	—	—	—	60 x 30
Chevron Alignment	W1-8	2C.09	18 x 24	18 x 24	30 x 36	36 x 48	—	24 x 30
Combination Horizontal Alignment/Intersection	W1-10,10a,10b,10c,10d,10e	2C.11	36 x 36	36 x 36	36 x 36	48 x 48	—	—
Hairpin Curve	W1-11	2C.07	30 x 30	30 x 30	36 x 36	48 x 48	—	48 x 48
Truck Rollover	W1-13	2C.13	36 x 36	36 x 36	36 x 36	48 x 48	—	36 x 36
270-degree Loop	W1-15	2C.07	30 x 30	30 x 30	36 x 36	48 x 48	—	48 x 48
Intersection Warning	W2-1,2,3,4,5,6,7,8	2C.46	30 x 30	30 x 30	36 x 36	—	24 x 24	48 x 48
Advanced Traffic Control	W3-1,2,3	2C.36	30 x 30	30 x 30	48 x 48	48 x 48	30 x 30	—
Be Prepared to Stop	W3-4	2C.36	36 x 36	36 x 36	48 x 48	48 x 48	30 x 30	—
Reduced Speed Limit Ahead	W3-5	2C.38	36 x 36	36 x 36	48 x 48	48 x 48	—	—
XX MPH Speed Zone Ahead	W3-5a	2C.38	36 x 36	36 x 36	48 x 48	48 x 48	—	—
Draw Bridge	W3-6	2C.39	36 x 36	36 x 36	48 x 48	—	—	60 x 60
Ramp Meter Ahead	W3-7	2C.37	36 x 36	36 x 36	—	—	—	—
Ramp Metered When Flashing	W3-8	2C.37	36 x 36	36 x 36	—	—	—	—
Merge	W4-1	2C.40	36 x 36	36 x 36	48 x 48	48 x 48	30 x 30*	—
Lane Ends	W4-2	2C.42	36 x 36	36 x 36	48 x 48	48 x 48	30 x 30*	—
Added Lane	W4-3	2C.41	36 x 36	36 x 36	48 x 48	48 x 48	30 x 30*	—
Cross Traffic Does Not Stop (plaque)	W4-4P	2C.59	24 x 12	24 x 12	36 x 18	—	—	48 x 24
Traffic From Left (Right) Does Not Stop (plaque)	W4-4aP	2C.59	24 x 12	24 x 12	36 x 18	—	—	48 x 24
Oncoming Traffic Does Not Stop (plaque)	W4-4bP	2C.59	24 x 12	24 x 12	36 x 18	—	—	48 x 24
Entering Roadway Merge	W4-5	2C.40	36 x 36	36 x 36	48 x 48	—	—	—
No Merge Area (plaque)	W4-5P	2C.40	18 x 24	18 x 24	24 x 30	—	—	—
Entering Roadway Added Lane	W4-6	2C.41	36 x 36	36 x 36	48 x 48	—	—	—
Road Narrows	W5-1	2C.19	36 x 36	36 x 36	48 x 48	48 x 48	30 x 30*	—
Narrow Bridge	W5-2	2C.20	36 x 36	36 x 36	48 x 48	48 x 48	30 x 30*	—
One Lane Bridge	W5-3	2C.21	36 x 36	36 x 36	48 x 48	48 x 48	30 x 30*	—
Divided Highway	W6-1	2C.22	36 x 36	36 x 36	48 x 48	48 x 48	—	—
Divided Highway Ends	W6-2	2C.23	36 x 36	36 x 36	48 x 48	48 x 48	—	—
Two-Way Traffic	W6-3	2C.44	36 x 36	36 x 36	48 x 48	48 x 48	—	—
Hill	W7-1	2C.16	30 x 30*	36 x 36	36 x 36	36 x 36	24 x 24*	48 x 48
Hill with Grade	W7-1a	2C.16	30 x 30*	36 x 36	36 x 36	36 x 36	24 x 24*	48 x 48
Use Low Gear (plaque)	W7-2P	2C.57	24 x 18	24 x 18	—	—	—	—
Trucks Use Lower Gear (plaque)	W7-2bP	2C.57	24 x 18	24 x 18	—	—	—	—
XX% Grade (plaque)	W7-3P	2C.57	24 x 18	24 x 18	—	—	—	—
Next XX Miles (plaque)	W7-3aP	2C.55	24 x 18	24 x 18	—	—	—	—
XX% Grade, XX Miles (plaque)	W7-3bP	2C.57	24 x 18	24 x 18	—	—	—	—
Runaway Truck Ramp XX Miles	W7-4	2C.17	78 x 48	78 x 48	78 x 48	78 x 48	—	—
Runaway Truck Ramp (with arrow)	W7-4b	2C.17	78 x 60	78 x 60	78 x 60	78 x 60	—	—
Truck Escape Ramp	W7-4c	2C.17	78 x 60	78 x 60	78 x 60	78 x 60	—	—
Sand, Gravel, Paved (plaques)	W7-4dP, 4eP, 4fP	2C.17	24 x 12	24 x 12	24 x 12	24 x 12	—	—
Hill Blocks View	W7-6	2C.18	30 x 30*	36 x 36	36 x 36	—	—	48 x 48
Bump or Dip	W8-1,2	2C.28	30 x 30*	36 x 36	36 x 36	48 x 48	24 x 24*	48 x 48



**Table 2C-2. Warning Sign and Plaque Sizes (Sheet 2 of 3)**

Sign or Plaque	Sign Designation	Section	Conventional Road		Expressway	Freeway	Minimum	Oversized
			Single Lane	Multi-Lane				
Pavement Ends	W8-3	2C.30	36 x 36	36 x 36	48 x 48	—	30 x 30*	—
Soft Shoulder	W8-4	2C.31	36 x 36	36 x 36	48 x 48	48 x 48	24 x 24*	48 x 48
Slippery When Wet	W8-5	2C.32	30 x 30*	36 x 36	36 x 36	48 x 48	24 x 24*	48 x 48
Road Condition (plaques)	W8-5P,5bP,5cP	2C.32	24 x 18	24 x 18	30 x 24	36 x 30	—	36 x 30
Ice	W8-5aP	2C.32	24 x 12	24 x 12	30 x 18	30 x 18	—	—
Truck Crossing	W8-6	2C.49	36 x 36	36 x 36	36 x 36	48 x 48	24 x 24*	48 x 48
Loose Gravel	W8-7	2C.32	36 x 36	36 x 36	36 x 36	—	24 x 24*	48 x 48
Rough Road	W8-8	2C.32	36 x 36	36 x 36	36 x 36	48 x 48	24 x 24*	48 x 48
Low Shoulder	W8-9	2C.31	36 x 36	36 x 36	36 x 36	48 x 48	24 x 24*	48 x 48
Uneven Lanes	W8-11	2C.32	36 x 36	36 x 36	36 x 36	48 x 48	—	48 x 48
No Center Line	W8-12	2C.34	36 x 36	36 x 36	36 x 36	48 x 48	—	—
Bridge Ices Before Road	W8-13	2C.32	36 x 36	36 x 36	36 x 36	48 x 48	24 x 24*	48 x 48
Fallen Rocks	W8-14	2C.32	30 x 30*	36 x 36	36 x 36	48 x 48	24 x 24*	48 x 48
Grooved Pavement	W8-15	2C.33	30 x 30*	36 x 36	36 x 36	48 x 48	24 x 24*	48 x 48
Motorcycle (plaque)	W8-15P	2C.33	24 x 18	24 x 18	30 x 24	36 x 30	—	36 x 30
Metal Bridge Deck	W8-16	2C.33	30 x 30*	36 x 36	36 x 36	48 x 48	24 x 24*	48 x 48
Shoulder Drop Off (symbol)	W8-17	2C.31	30 x 30*	36 x 36	36 x 36	48 x 48	24 x 24*	48 x 48
Shoulder Drop-Off (plaque)	W8-17P	2C.31	24 x 18	24 x 18	30 x 24	36 x 30	—	36 x 30
Road May Flood	W8-18	2C.35	36 x 36	36 x 36	36 x 36	48 x 48	24 x 24*	48 x 48
Flood Gauge	W8-19	2C.35	12 x 72	12 x 72	—	—	—	—
Gusty Winds Area	W8-21	2C.35	36 x 36	36 x 36	36 x 36	48 x 48	24 x 24*	48 x 48
Fog Area	W8-22	2C.35	36 x 36	36 x 36	36 x 36	48 x 48	24 x 24*	48 x 48
No Shoulder	W8-23	2C.31	36 x 36	36 x 36	36 x 36	48 x 48	24 x 24*	48 x 48
Shoulder Ends	W8-25	2C.31	30 x 30*	36 x 36	36 x 36	48 x 48	24 x 24*	48 x 48
Left (Right) Lane Ends	W9-1	2C.42	36 x 36	36 x 36	36 x 36	48 x 48	30 x 30*	48 x 48
Lane Ends Merge Left (Right)	W9-2	2C.42	36 x 36	36 x 36	36 x 36	48 x 48	30 x 30*	48 x 48
Right (Left) Lane Exit Only Ahead	W9-7	2C.43	132 x 72	132 x 72	132 x 72	132 x 72	—	—
Bicycle	W11-1	2C.49	30 x 30	30 x 30	36 x 36	—	24 x 24*	48 x 48
Pedestrian	W11-2	2C.50	30 x 30*	36 x 36	36 x 36	—	24 x 24*	48 x 48
Large Animals	W11-3,4,16,17,18,19,20,21,22	2C.50	30 x 30*	36 x 36	36 x 36	—	24 x 24*	48 x 48
Farm Vehicle	W11-5,5a	2C.49	30 x 30*	36 x 36	36 x 36	—	24 x 24*	48 x 48
Snowmobile	W11-6	2C.50	30 x 30*	36 x 36	36 x 36	—	24 x 24*	48 x 48
Equestrian	W11-7	2C.50	30 x 30*	36 x 36	36 x 36	—	24 x 24*	48 x 48
Emergency Vehicle	W11-8	2C.49	30 x 30*	36 x 36	36 x 36	—	24 x 24*	48 x 48
Handicapped	W11-9	2C.50	30 x 30*	36 x 36	36 x 36	—	—	48 x 48
Truck	W11-10	2C.49	30 x 30*	36 x 36	36 x 36	—	24 x 24*	48 x 48
Golf Cart	W11-11	2C.49	30 x 30*	36 x 36	36 x 36	—	24 x 24*	48 x 48
Emergency Signal Ahead (plaque)	W11-12P	2C.49	36 x 30	36 x 30	36 x 30	—	—	—
Horse-Drawn Vehicle	W11-14	2C.49	30 x 30*	36 x 36	36 x 36	—	24 x 24*	48 x 48
Bicycle / Pedestrian	W11-15	2C.49	30 x 30*	36 x 36	36 x 36	—	24 x 24*	48 x 48
Trail Crossing	W11-15a	2C.49	30 x 30*	36 x 36	36 x 36	—	24 x 24*	48 x 48
Trail X-ing (plaque)	W11-15P	2C.49	24 x 18	24 x 18	30 x 24	—	—	36 x 30
Double Arrow	W12-1	2C.25	30 x 30*	36 x 36	36 x 36	—	—	—
Low Clearance (with arrows)	W12-2	2C.27	36 x 36	36 x 36	48 x 48	48 x 48	30 x 30*	—
Low Clearance	W12-2a	2C.27	78 x 24	78 x 24	—	—	—	—
Advisory Speed (plaque)	W13-1P	2C.08	18 x 18	18 x 18	24 x 24	30 x 30	—	30 x 30
Advisory Exit or Ramp Speed	W13-2,3	2C.14	24 x 30	24 x 30	36 x 48	36 x 48	—	48 x 60
Combination Horizontal Alignment/Advisory Exit or Ramp Speed	W13-6,7	2C.15	24 x 42	24 x 42	36 x 60	36 x 60	—	48 x 84
Dead End, No Outlet	W14-1,2	2C.26	30 x 30*	36 x 36	36 x 36	—	24 x 24*	48 x 48





**Table 2C-2. Warning Sign and Plaque Sizes (Sheet 3 of 3)**

Sign or Plaque	Sign Designation	Section	Conventional Road		Expressway	Freeway	Minimum	Oversized
			Single Lane	Multi-Lane				
Dead End, No Outlet (with arrow)	W14-1a,2a	2C.26	36 x 8	36 x 8	—	—	—	—
No Passing Zone (pennant)	W14-3	2C.45	48 x 48 x 36	48 x 48 x 36	—	—	40 x 40 x 30	64 x 64 x 48
Playground	W15-1	2C.51	30 x 30*	36 x 36	36 x 36	—	24 x 24*	48 x 48
Share the Road (plaque)	W16-1P	2C.60	18 x 24	18 x 24	24 x 30	—	—	24 x 30
XX Feet	W16-2P	2C.55	24 x 18	24 x 18	—	—	—	30 x 24
XX Ft	W16-2aP	2C.55	24 x 12	24 x 12	—	—	—	30 x 18
XX Miles (2-line plaque)	W16-3P	2C.55	30 x 24	30 x 24	—	—	—	—
XX Miles (1-line plaque)	W16-3aP	2C.55	30 x 12	30 x 12	—	—	—	—
Next XX Feet (plaque)	W16-4P	2C.55	30 x 24	30 x 24	—	—	—	—
Supplemental Arrow (plaque)	W16-5P,6P	2C.56	24 x 18	24 x 18	—	—	—	—
Downward Diagonal Arrow (plaque)	W16-7P	2C.50	24 x 12	24 x 12	—	—	—	30 x 18
Advance Street Name (1-line plaque)	W16-8P	2C.58	Varies x 8	Varies x 8	—	—	—	—
Advance Street Name (2-line plaque)	W16-8aP	2C.58	Varies x 15	Varies x 15	—	—	—	—
Ahead (plaque)	W16-9P	2C.50	24 x 12	24 x 12	30 x 18	—	—	—
Photo Enforced (symbol plaque)	W16-10P	2C.61	24 x 12	24 x 12	36 x 18	—	—	48 x 24
Photo Enforced (plaque)	W16-10aP	2C.61	24 x 18	24 x 18	36 x 30	—	—	48 x 36
HOV (plaque)	W16-11P	2G.09	24 x 12	24 x 12	30 x 18	—	—	30 x 18
Traffic Circle (plaque)	W16-12P	2C.46	24 x 18	24 x 18	—	—	—	—
When Flashing (plaque)	W16-13P	2C.50	24 x 18	24 x 18	—	—	—	—
New (plaque)	W16-15P	2C.62	24 x 12	24 x 12	—	—	—	—
Roundabout (plaque)	W16-17P	2C.46	24 x 12	24 x 12	—	—	—	—
NOTICE	W16-18P	2A.15	24 x 12	24 x 12	—	—	—	—
Speed Hump	W17-1	2C.29	30 x 30*	36 x 36	—	—	24 x 24*	48 x 48
Freeway Ends XX Miles	W19-1	2C.24	—	—	—	144 x 48	—	—
Expressway Ends XX Miles	W19-2	2C.24	—	—	144 x 48	—	—	—
Freeway Ends	W19-3	2C.24	—	—	—	48 x 48	—	—
Expressway Ends	W19-4	2C.24	—	—	48 x 48	—	—	—
All Traffic Must Exit	W19-5	2C.24	—	—	90 x 48	90 x 48	—	—
New Traffic Pattern Ahead	W23-2	2C.52	36 x 36	36 x 36	—	—	—	—
Traffic Signal Extended Green	W25-1,2	2C.48	24 x 30	24 x 30	—	—	—	—

\* The minimum size required for diamond-shaped warning signs facing traffic on multi-lane conventional roads shall be 36 x 36 per Section 2C.04

- Notes: 1. Larger signs may be used when appropriate  
2. Dimensions in inches are shown as width x height

Support:

- 02 Section 2A.11 contains information regarding the applicability of the various columns in Table 2C-2.

**Standard:**

- 03 **Except as provided in Paragraph 5, the minimum size for all diamond-shaped warning signs facing traffic on a multi-lane conventional road where the posted speed limit is higher than 35 mph shall be 36 x 36 inches.**

- 04 **The minimum size for supplemental warning plaques that are not included in Table 2C-2 shall be as shown in Table 2C-3.**

Option:

- 05 If a diamond-shaped warning sign is placed on the left-hand side of a multi-lane roadway to supplement the installation of the same warning sign on the right-hand side of the roadway, the minimum size identified in the Single Lane column in Table 2C-2 may be used.

**Table 2C-3. Minimum Size of Supplemental Warning Plaques**

Size of Warning Sign	Size of Supplemental Plaque			
	Rectangular			Square
	1 Line	2 Lines	Arrow	
24 x 24	24 x 12	24 x 18	24 x 12	18 x 18
30 x 30				
36 x 36	30 x 18	30 x 24	30 x 18	24 x 24
48 x 48				

- Notes: 1. Larger supplemental plaques may be used when appropriate  
2. Dimensions in inches are shown as width x height



Chapter 2C  
Warning

**NDOT Signs Sizes**

Type	Code	W	H	Type	Code	W	H
WNV	1 - 1	V	x 30	WNV	15 - 8	36	x 36
WNV	1 - 2	V	x 30	WNV	15 - 8	48	x 48
WNV	1 - 3	V	x 30	WNV	16 - 1	108	x 60
WNV	2 - 1	96	x 60	WNV	16 - 2	48	x 24
WNV	3 - 1	36	x 30	WNV	16 - 3	48	x 24
WNV	4 - 1	36	x 36	WNV	16 - 4	40	x 36
WNV	4 - 1	48	x 48	WNV	16 - 5	78	x 48
WNV	5 - 1	108	x 48	WNV	17 - 1	36	x 36
WNV	5 - 1	180	x 72	WNV	17 - 1	48	x 48
WNV	6 - 1	36	x 36	WNV	18 - 1	36	x 42
WNV	6 - 1	48	x 48	WNV	18 - 1	54	x 60
WNV	7 - 1	54	x 66	WNV	19 - 2	42	x 42
WNV	7 - 1	90	x 102	WNV	20 - 1	30	x 24
WNV	7 - 2	72	x 48	WNV	21 - 1	30	x 48
WNV	7 - 2	102	x 72	WNV	22 - 1	36	x 36
WNV	8 - 1	36	x 36	WNV	22 - 1	48	x 48
WNV	8 - 1	48	x 48	WNV	23 - 1	36	x 36
WNV	9 - 1	36	x 36	WNV	23 - 1	48	x 48
WNV	9 - 1	48	x 48	WNV	24 - 1	36	x 36
WNV	10 - 1	36	x 36	WNV	24 - 1	48	x 48
WNV	10 - 1	48	x 48	WNV	25 - 1	42	x 54
WNV	11 - 1	36	x 36	WNV	26 - 1	36	x 36
WNV	11 - 1	48	x 48	WNV	26 - 1	48	x 48
WNV	12 - 1	36	x 36	WNV	27 - 1	36	x 36
WNV	12 - 1	48	x 48	WNV	27 - 1	48	x 48
WNV	12 - 2	36	x 36	WNV	27 - 2	36	x 36
WNV	12 - 2	48	x 48	WNV	27 - 2	48	x 48
WNV	12 - 3	36	x 36	WNV	28 - 1	36	x 36
WNV	12 - 3	48	x 48	WNV	28 - 1	48	x 48
WNV	13 - 1	24	x 18	WNV	29 - 1	36	x 36
WNV	14 - 1	36	x 36	WNV	29 - 1	48	x 48
WNV	14 - 1	48	x 48	WNV	30 - 1	36	x 36
WNV	15 - 1	36	x 36	WNV	31 - 1	36	x 36
WNV	15 - 1	48	x 48	WNV	31 - 1	48	x 48
WNV	15 - 2	36	x 36	WNV	31 - 2	36	x 36
WNV	15 - 2	48	x 48	WNV	31 - 2	48	x 48
WNV	15 - 3	36	x 36				
WNV	15 - 3	48	x 48				
WNV	15 - 4	36	x 36				
WNV	15 - 4	48	x 48				
WNV	15 - 5	36	x 36				
WNV	15 - 5	48	x 48				
WNV	15 - 6	36	x 36				
WNV	15 - 6	48	x 48				
WNV	15 - 7	36	x 36				
WNV	15 - 7	48	x 48				



06 Signs and plaques larger than those shown in Tables 2C-2 and 2C-3 may be used (see Section 2A.11).

*Guidance:*

07 *The minimum size for all diamond-shaped warning signs facing traffic on exit and entrance ramps should be the size identified in Table 2C-2 for the mainline roadway classification (Expressway or Freeway). If a minimum size is not provided in the Freeway Column, the Expressway size should be used. If a minimum size is not provided in the Freeway or the Expressway Column, the Oversized size should be used.*

**Section 2C.05 Placement of Warning Signs**

Support:

01 For information on placement of warning signs, see Sections 2A.16 to 2A.21.

02 The time needed for detection, recognition, decision, and reaction is called the Perception-Response Time (PRT). Table 2C-4 is provided as an aid for determining warning sign location. The distances shown in Table 2C-4 can be adjusted for roadway features, other signing, and to improve visibility.

*Guidance:*

03 *Warning signs should be placed so that they provide an adequate PRT. The distances contained in Table 2C-4 are for guidance purposes and should be applied with engineering judgment. Warning signs should not be placed too far in advance of the condition, such that drivers might tend to forget the warning because of other driving distractions, especially in urban areas.*

**Table 2C-4. Guidelines for Advance Placement of Warning Signs**

Posted or 85th-Percentile Speed	Advance Placement Distance <sup>1</sup>								
	Condition A: Speed reduction and lane changing in heavy traffic <sup>2</sup>	Condition B: Deceleration to the listed advisory speed (mph) for the condition							
		0 <sup>3</sup>	10 <sup>4</sup>	20 <sup>4</sup>	30 <sup>4</sup>	40 <sup>4</sup>	50 <sup>4</sup>	60 <sup>4</sup>	70 <sup>4</sup>
20 mph	225 ft	100 ft <sup>6</sup>	N/A <sup>5</sup>	—	—	—	—	—	—
25 mph	325 ft	100 ft <sup>6</sup>	N/A <sup>5</sup>	N/A <sup>5</sup>	—	—	—	—	—
30 mph	460 ft	100 ft <sup>6</sup>	N/A <sup>5</sup>	N/A <sup>5</sup>	—	—	—	—	—
35 mph	565 ft	100 ft <sup>6</sup>	N/A <sup>5</sup>	N/A <sup>5</sup>	N/A <sup>5</sup>	—	—	—	—
40 mph	670 ft	125 ft	100 ft <sup>6</sup>	100 ft <sup>6</sup>	N/A <sup>5</sup>	—	—	—	—
45 mph	775 ft	175 ft	125 ft	100 ft <sup>6</sup>	100 ft <sup>6</sup>	N/A <sup>5</sup>	—	—	—
50 mph	885 ft	250 ft	200 ft	175 ft	125 ft	100 ft <sup>6</sup>	—	—	—
55 mph	990 ft	325 ft	275 ft	225 ft	200 ft	125 ft	N/A <sup>5</sup>	—	—
60 mph	1,100 ft	400 ft	350 ft	325 ft	275 ft	200 ft	100 ft <sup>6</sup>	—	—
65 mph	1,200 ft	475 ft	450 ft	400 ft	350 ft	275 ft	200 ft	100 ft <sup>6</sup>	—
70 mph	1,250 ft	550 ft	525 ft	500 ft	450 ft	375 ft	275 ft	150 ft	—
75 mph	1,350 ft	650 ft	625 ft	600 ft	550 ft	475 ft	375 ft	250 ft	100 ft <sup>6</sup>

<sup>1</sup> The distances are adjusted for a sign legibility distance of 180 feet for Condition A. The distances for Condition B have been adjusted for a sign legibility distance of 250 feet, which is appropriate for an alignment warning symbol sign. For Conditions A and B, warning signs with less than 6-inch legend or more than four words, a minimum of 100 feet should be added to the advance placement distance to provide adequate legibility of the warning sign.

<sup>2</sup> Typical conditions are locations where the road user must use extra time to adjust speed and change lanes in heavy traffic because of a complex driving situation. Typical signs are Merge and Right Lane Ends. The distances are determined by providing the driver a PRT of 14.0 to 14.5 seconds for vehicle maneuvers (2005 AASHTO Policy, Exhibit 3-3, Decision Sight Distance, Avoidance Maneuver E) minus the legibility distance of 180 feet for the appropriate sign.

<sup>3</sup> Typical condition is the warning of a potential stop situation. Typical signs are Stop Ahead, Yield Ahead, Signal Ahead, and Intersection Warning signs. The distances are based on the 2005 AASHTO Policy, Exhibit 3-1, Stopping Sight Distance, providing a PRT of 2.5 seconds, a deceleration rate of 11.2 feet/second<sup>2</sup>, minus the sign legibility distance of 180 feet.

<sup>4</sup> Typical conditions are locations where the road user must decrease speed to maneuver through the warned condition. Typical signs are Turn, Curve, Reverse Turn, or Reverse Curve. The distance is determined by providing a 2.5 second PRT, a vehicle deceleration rate of 10 feet/second<sup>2</sup>, minus the sign legibility distance of 250 feet.

<sup>5</sup> No suggested distances are provided for these speeds, as the placement location is dependent on site conditions and other signing. An alignment warning sign may be placed anywhere from the point of curvature up to 100 feet in advance of the curve. However, the alignment warning sign should be installed in advance of the curve and at least 100 feet from any other signs.

<sup>6</sup> The minimum advance placement distance is listed as 100 feet to provide adequate spacing between signs.





**Standard:**

02 **In advance of horizontal curves on freeways, on expressways, and on roadways with more than 1,000 AADT that are functionally classified as arterials or collectors, horizontal alignment warning signs shall be used in accordance with Table 2C-5 based on the speed differential between the roadway's posted or statutory speed limit or 85th-percentile speed, whichever is higher, or the prevailing speed on the approach to the curve, and the horizontal curve's advisory speed.**

Option:

03 Horizontal Alignment Warning signs may also be used on other roadways or on arterial and collector roadways with less than 1,000 AADT based on engineering judgment.

**Section 2C.07 Horizontal Alignment Signs (W1-1 through W1-5, W1-11, W1-15)**

**Standard:**

01 **If Table 2C-5 indicates that a horizontal alignment sign (see Figure 2C-1) is required, recommended, or allowed, the sign installed in advance of the curve shall be a Curve (W1-2) sign unless a different sign is recommended or allowed by the provisions of this Section.**

02 **A Turn (W1-1) sign shall be used instead of a Curve sign in advance of curves that have advisory speeds of 30 mph or less (see Figure 2C-2).**

Guidance:

03 *Where there are two changes in roadway alignment in opposite directions that are separated by a tangent distance of less than 600 feet, the Reverse Turn (W1-3) sign should be used instead of multiple Turn (W1-1) signs and the Reverse Curve (W1-4) sign should be used instead of multiple Curve (W1-2) signs.*

Option:

04 A Winding Road (W1-5) sign may be used instead of multiple Turn (W1-1) or Curve (W1-2) signs where there are three or more changes in roadway alignment each separated by a tangent distance of less than 600 feet.

05 A NEXT XX MILES (W7-3aP) supplemental distance plaque (see Section 2C.55) may be installed below the Winding Road sign where continuous roadway curves exist for a specific distance.

06 If the curve has a change in horizontal alignment of 135 degrees or more, the Hairpin Curve (W1-11) sign may be used instead of a Curve or Turn sign.

07 If the curve has a change of direction of approximately 270 degrees, such as on a cloverleaf interchange ramp, the 270-degree Loop (W1-15) sign may be used instead of a Curve or Turn sign.

Guidance:

08 *When the Hairpin Curve sign or the 270-degree Loop sign is installed, either a One-Direction Large Arrow (W1-6) sign or Chevron Alignment (W1-8) signs should be installed on the outside of the turn or curve.*

**Table 2C-5. Horizontal Alignment Sign Selection**

Type of Horizontal Alignment Sign	Difference Between Speed Limit and Advisory Speed				
	5 mph	10 mph	15 mph	20 mph	25 mph or more
Turn (W1-1), Curve (W1-2), Reverse Turn (W1-3), Reverse Curve (W1-4), Winding Road (W1-5), and Combination Horizontal Alignment/Intersection (W10-1) (see Section 2C.07 to determine which sign to use)	Recommended	Required	Required	Required	Required
Advisory Speed Plaque (W13-1P)	Recommended	Required	Required	Required	Required
Chevrons (W1-8) and/or One Direction Large Arrow (W1-6)	Optional	Recommended	Required	Required	Required
Exit Speed (W13-2) and Ramp Speed (W13-3) on exit ramp	Optional	Optional	Recommended	Required	Required

Note: Required means that the sign and/or plaque shall be used, recommended means that the sign and/or plaque should be used, and optional means that the sign and/or plaque may be used.

See Section 2C.06 for roadways with less than 1,000 ADT.



**Section 2C.08 Advisory Speed Plaque (W13-1P)**

**Option:**

- 01 The Advisory Speed (W13-1P) plaque (see Figure 2C-1) may be used to supplement any warning sign to indicate the advisory speed for a condition.

**Standard:**

- 02 **The use of the Advisory Speed plaque for horizontal curves shall be in accordance with the information shown in Table 2C-5. The Advisory Speed plaque shall also be used where an engineering study indicates a need to advise road users of the advisory speed for other roadway conditions.**
- 03 **If used, the Advisory Speed plaque shall carry the message XX MPH. The speed displayed shall be a multiple of 5 mph.**
- 04 **Except in emergencies or when the condition is temporary, an Advisory Speed plaque shall not be installed until the advisory speed has been determined by an engineering study.**
- 05 **The Advisory Speed plaque shall only be used to supplement a warning sign and shall not be installed as a separate sign installation.**
- 06 **The advisory speed shall be determined by an engineering study that follows established engineering practices.**

**Support:**

- 07 Among the established engineering practices that are appropriate for the determination of the recommended advisory speed for a horizontal curve are the following:
- A. An accelerometer that provides a direct determination of side friction factors
  - B. A design speed equation
  - C. A traditional ball-bank indicator using the following criteria:
    - 1. 16 degrees of ball-bank for speeds of 20 mph or less
    - 2. 14 degrees of ball-bank for speeds of 25 to 30 mph
    - 3. 12 degrees of ball-bank for speeds of 35 mph and higher

- 08 The 16, 14, and 12 degrees of ball-bank criteria are comparable to the current AASHTO horizontal curve design guidance. Research has shown that drivers often exceed existing posted advisory curve speeds by 7 to 10 mph.

**Guidance:**

- 09 *The advisory speed should be determined based on free-flowing traffic conditions.*
- 10 *Because changes in conditions, such as roadway geometrics, surface characteristics, or sight distance, might affect the advisory speed, each location should be evaluated periodically or when conditions change.*



# **2D - Guide**

# **Conventional Roads**



# Guide - Conventional Roads



M1-1 11



M1-5 164



M1-5 582



M1-6 215



M1-1 15



M1-5 165



M1-5 592



M1-1 215



M1-5 168



M1-5 593



M1-7 XX



M1-1 515



M1-5 169



M1-5 594



M1-4 93



M1-5 170



M1-5 595



M1-4 95



M1-5 171



M1-5 599



M1-5 146



M1-5 172



M1-5 602



M1-5 147



M1-5 173



M1-5 604



M1-5 156



M1-5 562



M1-5 610



M1-5 157



M1-5 564



M1-5 612



M1-5 158



M1-5 573



M1-5 739



M1-5 159



M1-5 574



M1-5 160



M1-5 578



M1-5 161



M1-5 579



M1-5 163



























































































Interstate

US and State

Forest and Recreational

County

 M2-1	 M2-1 A	 M2-1 B	 M2-1 C
 M3-1	 M3-1 A	 M3-1 B	 M3-1 C
 M3-2	 M3-2 A	 M3-2 B	 M3-2 C
 M3-3	 M3-3 A	 M3-3 B	 M3-3 C
 M3-4	 M3-4 A	 M3-4 B	 M3-4 C
 M4-1	 M4-1 A	 M4-1 B	 M4-1 C
 M4-1a	 M4-1a A	 M4-1a B	 M4-1a C
 M4-2	 M4-2 A	 M4-2 B	 M4-2 C
 M4-5	 M4-5 A	 M4-5 B	 M4-5 C
 M4-6	 M4-6 A	 M4-6 B	 M4-6 C
 M4-7	 M4-7 A	 M4-7 B	 M4-7 C
 M4-7a	 M4-7a A	 M4-7a B	 M4-7a C
 M4-14	 M4-14 A	 M4-14 B	 M4-14 C
 M5-1L	 M5-1L A	 M5-1L B	 M5-1L C
 M5-1R	 M5-1R A	 M5-1R B	 M5-1R C
 M5-2L	 M5-2L A	 M5-2L B	 M5-2L C
 M5-2R	 M5-2R A	 M5-2R B	 M5-2R C
 M5-3	 M5-3 A	 M5-3 B	 M5-3 C
 M5-4	 M5-4 A	 M5-4 B	 M5-4 C
 M5-4a	 M5-4a A	 M5-4a B	 M5-4a C
 M5-5	 M5-5 A	 M5-5 B	 M5-5 C
 M5-6	 M5-6 A	 M5-6 B	 M5-6 C





## Guide - Conventional Roads

### Interstate

	M6-1
	M6-2L
	M6-2R
	M6-3
	M6-4
	M6-5L
	M6-5R
	M6-6L
	M6-6R
	M6-7L
	M6-7R

### US and State

	M6-1 A
	M6-2L A
	M6-2R A
	M6-3 A
	M6-4 A
	M6-5L A
	M6-5R A
	M6-6L A
	M6-6R A
	M6-7L A
	M6-7R A

### Forest and Recreational

	M6-1 B
	M6-2L B
	M6-2R B
	M6-3 B
	M6-4 B
	M6-5L B
	M6-5R B
	M6-6L B
	M6-6R B
	M6-7L B
	M6-7R B

### County

	M6-1 C
	M6-2L C
	M6-2R C
	M6-3 C
	M6-4 C
	M6-5L C
	M6-5R C
	M6-6L C
	M6-6R C
	M6-7L C
	M6-7R C

	D1-1
	D1-2
	D1-3
	D15-1
	D15-1a

	D3-1 (post mounted)
	D3-1OH (overhead mounted)
	D3-2

	D4-1
	D4-2L
	D4-2R

	D6-4
	D6-4a

	D8-1
	D8-2
	D8-3



**Table 2D-1. Conventional Road Guide Sign Sizes**

Sign	Sign Designation	Section	Conventional Road	Minimum	Oversized
Interstate Route Sign (1 or 2 digits)	M1-1	2D.11	24 x 24	24 x 24	36 x 36
Interstate Route Sign (3 digits)	M1-1	2D.11	30 x 24	30 x 24	45 x 36
Off-Interstate Route Sign (1 or 2 digits)	M1-2,3	2D.11	24 x 24	24 x 24	36 x 36
Off-Interstate Route Sign (3 digits)	M1-2,3	2D.11	30 x 24	30 x 24	45 x 36
U.S. Route Sign (1 or 2 digits)	M1-4	2D.11	24 x 24	24 x 24	36 x 36
U.S. Route Sign (3 digits)	M1-4	2D.11	30 x 24	30 x 24	45 x 36
State Route Sign (1 or 2 digits)	M1-5	2D.11	24 x 24	24 x 24	36 x 36
State Route Sign (3 digits)	M1-5	2D.11	30 x 24	30 x 24	45 x 36
County Route Sign (1, 2, or 3 digits)	M1-6	2D.11	24 x 24	24 x 24	36 x 36
Forest Route (1, 2, or 3 digits)	M1-7	2D.11	24 x 24	18 x 18	36 x 36
Junction	M2-1	2D.13	21 x 15	21 x 15	30 x 21
Combination Junction (2 route signs)	M2-2	2D.14	60 x 48*	—	—
Cardinal Direction	M3-1,2,3,4	2D.15	24 x 12	24 x 12	36 x 18
Alternate	M4-1,1a	2D.17	24 x 12	24 x 12	36 x 18
By-Pass	M4-2	2D.18	24 x 12	24 x 12	36 x 18
Business	M4-3	2D.19	24 x 12	24 x 12	36 x 18
Truck	M4-4	2D.20	24 x 12	24 x 12	36 x 18
To	M4-5	2D.21	24 x 12	24 x 12	36 x 18
End	M4-6	2D.22	24 x 12	24 x 12	36 x 18
Temporary	M4-7,7a	2D.24	24 x 12	24 x 12	36 x 18
Begin	M4-14	2D.23	24 x 12	24 x 12	36 x 18
Advance Turn Arrow	M5-1,2,3	2D.26	21 x 15	21 x 15	—
Lane Designation	M5-4,5,6	2D.27	24 x 18	24 x 18	36 x 24
Directional Arrow	M6-1,2,2a,3,4,5,6,7	2D.28	21 x 15	21 x 15	30 x 21
Destination (1 line)	D1-1	2D.37	Varies x 18	Varies x 18	—
Destination and Distance (1 line)	D1-1a	2D.37	Varies x 18	Varies x 18	—
Circular Intersection Destination (1 line)	D1-1d	2D.38	Varies x 18	Varies x 18	—
Circular Intersection Departure Guide	D1-1e	2D.38	Varies x 42*	—	—
Destination (2 lines)	D1-2	2D.37	Varies x 30	Varies x 30	—
Destination and Distance (2 lines)	D1-2a	2D.37	Varies x 30	Varies x 30	—
Circular Intersection Destination (2 lines)	D1-2d	2D.38	Varies x 30	Varies x 30	—
Destination (3 lines)	D1-3	2D.37	Varies x 42	Varies x 42	—
Destination and Distance (3 lines)	D1-3a	2D.37	Varies x 42	Varies x 42	—
Circular Intersection Destination (3 lines)	D1-3d	2D.38	Varies x 42	Varies x 42	—
Distance (1 line)	D2-1	2D.41	Varies x 18	Varies x 18	—
Distance (2 lines)	D2-2	2D.41	Varies x 30	Varies x 30	—
Distance (3 lines)	D2-3	2D.41	Varies x 42	Varies x 42	—
Street Name (1 line)	D3-1,1a	2D.43	Varies x 12	Varies x 8	Varies x 18
Advance Street Name (2 lines)	D3-2	2D.44	Varies x 30*	—	—
Advance Street Name (3 lines)	D3-2	2D.44	Varies x 42*	—	—
Advance Street Name (4 lines)	D3-2	2D.44	Varies x 60*	—	—
Parking Area	D4-1	2D.47	30 x 24	18 x 15	—
Park - Ride	D4-2	2D.48	30 x 36	24 x 30	36 x 48
National Scenic Byways	D6-4	2D.55	24 x 24	24 x 24	—
National Scenic Byways	D6-4a	2D.55	24 x 12	24 x 12	—
Weigh Station XX Miles	D8-1	2D.49	78 x 60	60 x 48	96 x 72
Weigh Station Next Right	D8-2	2D.49	84 x 72	66 x 54	108 x 90
Weigh Station (with arrow)	D8-3	2D.49	66 x 60	48 x 42	84 x 78
Crossover	D13-1,2	2D.54	60 x 30	60 x 30	78 x 42
Freeway Entrance	D13-3	2D.46	48 x 30	48 x 30	—
Freeway Entrance (with arrow)	D13-3a	2D.46	48 x 42	48 x 42	—
Combination Lane Use / Destination	D15-1	2D.33	Varies x 96	Varies x 96	—
Next Truck Lane XX Miles	D17-1	2D.51	42 x 48	42 x 48	60 x 66
Truck Lane XX Miles	D17-2	2D.51	42 x 42	42 x 42	60 x 54
Slow Vehicle Turn-Out XX Miles	D17-7	2D.52	72 x 42	72 x 42	96 x 54

\*The size shown is for a typical sign. The size should be appropriately based on the amount of legend required for the sign.

- Notes: 1. Larger signs may be used when appropriate  
 2. Dimensions in inches are shown as width x height



# Typical Route Assemblies

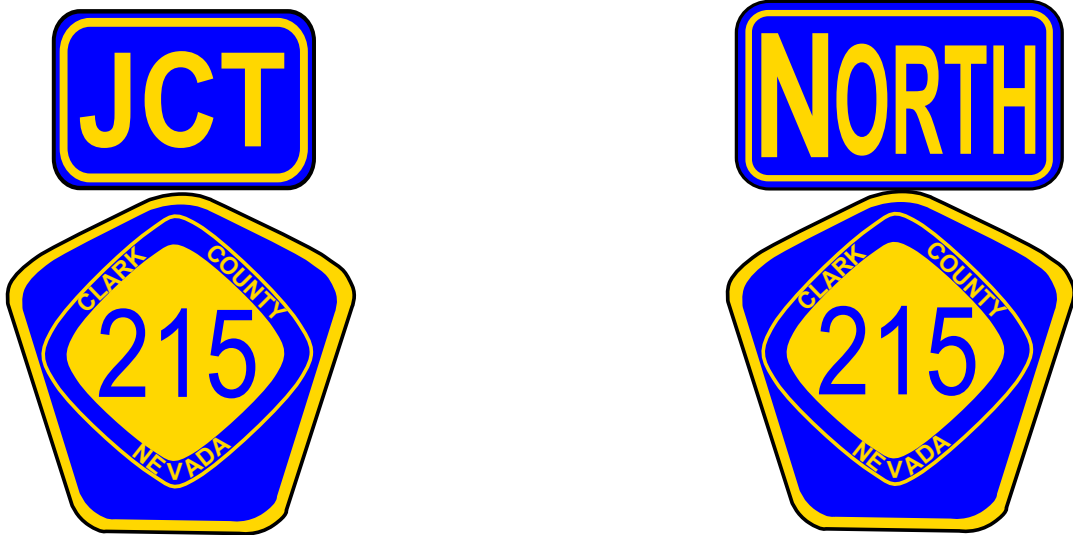

# 2E - Guide

# Controlled Access



### Guide - Controlled Access

* 	E11-1		E1-5P 27		E5-1a 1		E5-1a 16
	E11-1a		E1-5P 28		E5-1a 2		E5-1a 17
	E11-1b		E1-5P 29		E5-1a 3A		E5-1a 18
	E11-1c		E1-5P 30		E5-1a 3B		E5-1a 19
** 	E11-1d		E1-5P 32		E5-1a 5		E5-1a 20
** 	E11-1e		E1-5P 33		E5-1a 6		E5-1a 21
* 	E11-1f		E1-5P 35		E5-1a 7		E5-1a 22
	E1-5P 1		E1-5P 37		E5-1a 8		E5-1a 23
	E1-5P 2		E1-5P 38A		E5-1a 9		E5-1a 24
	E1-5P 3A		E1-5P 38B		E5-1a 10		E5-1a 25
	E1-5P 3B		E1-5P 40		E5-1a 11		E5-1a 26
	E1-5P 5		E1-5P 41		E5-1a 12A		E5-1a 27
	E1-5P 6		E1-5P 43		E5-1a 12B		E5-1a 28
	E1-5P 7		E1-5P 45		E5-1a 13		E5-1a 29
	E1-5P 8		E1-5P 46		E5-1a 14		E5-1a 30
	E1-5P 9		E1-5P 47				
	E1-5P 10		E1-5P 48				
	E1-5P 11		E1-5P 49				
	E1-5P 12A		E1-5P 50				
	E1-5P 12B		E1-5P 1				
	E1-5P 13		E1-5aP				
	E1-5P 14		E99-1				
	E1-5P 15		E99-2 XX				
	E1-5P 16		E5-1				
	E1-5P 17						
	E1-5P 18						
	E1-5P 19						
	E1-5P 20						
	E1-5P 21						
	E1-5P 23						
	E1-5P 25						
	E1-5P 26						



Guide - Controlled Access



E5-1a 32



E5-1a 50



E6-2 N (YXX)



E5-1a 33



E5-1a 51



E6-2 E (YXX)



E5-1a 35



E13-1P 15



E13-1P 20



E13-1P 25



E5-1a 37



E13-1P 30



E13-1P 35



E6-2 S (YXX)



E5-1a 38A



E13-1P 40



E13-1P 45



E5-1a 38B



E13-1P 50



E13-1P 55



E6-2 W (YXX)



E5-1a 40



E13-1P 60



E5-1a 41



E6-2a Z (YXX)

Where Z is  
N - North  
E - East  
S - South  
W - West

Where Y is  
I - Interstate  
U - US Route  
N - State Route  
C - County

XX is route number



E5-1a 43



E5-1a 45



IS1-1

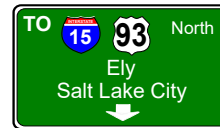

GS1-1



E5-1a 46

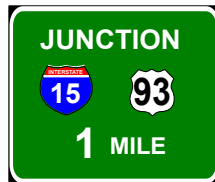

M2-2A



E1-5 35

GS2-1



E5-1a 47



E5-1a 48



GS2-2



E5-1a 49





## Guide - Controlled Access

### NDOT - Guide - Controlled Access

 GNV4-1

 GNV4-2

 GNV4-3

### NDOT Signs Sizes

Type	Code	W	H
GNV	4 - 1	42	24
GNV	4 - 2	60	24
GNV	4 - 3	66	24



## Guide - Controlled Access

Table 2E-1. Freeway or Expressway Guide Sign and Plaque Sizes (Sheet 1 of 2)

Sign or Plaque	Sign Designation	Section	Minimum Size
<b>Exit Number (plaque)</b>			
1-, 2-Digit Exit Number	E1-5P	2E.31	114 x 30
3-Digit Exit Number	E1-5P	2E.31	132 x 30
1-, 2-Digit Exit Number (with single letter suffix)	E1-5P	2E.31	138 x 30
3-Digit Exit Number (with single letter suffix)	E1-5P	2E.31	156 x 30
1-, 2-Digit Exit Number (with dual letter suffix)	E1-5P	2E.31	168 x 30
3-Digit Exit Number (with dual letter suffix)	E1-5P	2E.31	186 x 30
Left (plaque)	E1-5aP	2E.33	72 x 30
<b>Left Exit Number (plaque)</b>			
1-, 2-Digit Exit Number	E1-5bP	2E.31	114 x 54
3-Digit Exit Number	E1-5bP	2E.31	132 x 54
1-, 2-Digit Exit Number (with single letter suffix)	E1-5bP	2E.31	138 x 54
3-Digit Exit Number (with single letter suffix)	E1-5bP	2E.31	156 x 54
1-, 2-Digit Exit Number (with dual letter suffix)	E1-5bP	2E.31	168 x 54
3-Digit Exit Number (with dual letter suffix)	E1-5bP	2E.31	186 x 54
Next Exit XX Miles (1 line)	—	2E.34	Varies x 24
Next Exit XX Miles (2 lines)	—	2E.34	Varies x 36
Exit Gore (no exit number)	E5-1	2E.37	72 x 60
<b>Exit Gore (with exit number)</b>			
1-, 2-Digit Exit Number	E5-1a	2E.37	78 x 60
3-Digit Exit Number	E5-1a	2E.37	96 x 60
1-Digit Exit Number (with single letter suffix)	E5-1a	2E.37	90 x 60
2-Digit Exit Number (with single letter suffix)	E5-1a	2E.37	108 x 60
3-Digit Exit Number (with single letter suffix)	E5-1a	2E.37	126 x 60
1-Digit Exit Number (with dual letter suffix)	E5-1a	2E.37	120 x 60
2-Digit Exit Number (with dual letter suffix)	E5-1a	2E.37	138 x 60
3-Digit Exit Number (with dual letter suffix)	E5-1a	2E.37	156 x 60
<b>Exit Number (plaque)</b>			
1-, 2-Digit Exit Number	E5-1bP	2E.37	42 x 30
3-Digit Exit Number	E5-1bP	2E.37	60 x 30
1-Digit Exit Number (with single letter suffix)	E5-1bP	2E.37	48 x 30
1-Digit Exit Number (with dual letter suffix)	E5-1bP	2E.37	72 x 30
2-Digit Exit Number (with single or dual letter suffix)	E5-1bP	2E.37	72 x 30
3-Digit Exit Number (with single or dual letter suffix)	E5-1bP	2E.37	72 x 30
Narrow Exit Gore	E5-1c	2E.37	60 x 90*
Pull-Through	E6-2	2E.12	Varies x 120*
Pull-Through	E6-2a	2E.12	Varies x 90*
Exit Only (with arrow)	E11-1,1d	2E.24	174** x 36
Exit	E11-1a	2E.24	66 x 18
Only	E11-1b	2E.24	66 x 18
Exit Only	E11-1c	2E.24	120 x 18
Exit Only (with two arrows)	E11-1e,1f	2E.24	222** x 36
Left	E11-2	2E.40	60 x 18
Exit Gore Advisory Speed (plaque)	E13-1P	2E.37	72 x 24
Exit Direction Advisory Speed	E13-2	2E.36	162 x 24
Interstate Route Sign (1 or 2 digits)	M1-1	2E.27	36 x 36
Interstate Route Sign (3 digits)	M1-1	2E.27	45 x 36
Off-Interstate Route Sign (1 or 2 digits)	M1-2,3	2E.27	36 x 36
Off-Interstate Route Sign (3 digits)	M1-2,3	2E.27	45 x 36
U.S. Route Sign (1 or 2 digits)	M1-4	2E.27	36 x 36
U.S. Route Sign (3 digits)	M1-4	2E.27	45 x 36
State Route Sign (1 or 2 digits)	M1-5	2D.11	36 x 36



## Guide - Controlled Access

### Table 2E-1. Freeway or Expressway Guide Sign and Plaque Sizes (Sheet 2 of 2)

Sign or Plaque	Sign Designation	Section	Minimum Size
State Route Sign (3 digits)	M1-5	2D.11	45 x 36
County Route Sign (1, 2, or 3 digits)	M1-6	2D.11	36 x 36
Forest Route (1, 2, or 3 digits)	M1-7	2D.11	36 x 36
Eisenhower Interstate System	M1-10,10a	2E.28	36 x 36
Junction	M2-1	2D.13	30 x 21
Combination Junction (2 route signs)	M2-2	2D.14	60 x 48*
Cardinal Direction	M3-1,2,3,4	2D.15	36 x 18
Alternate	M4-1,1a	2D.17	36 x 18
By-Pass	M4-2	2D.18	36 x 18
Business	M4-3	2D.19	36 x 18
Truck	M4-4	2D.20	36 x 18
To	M4-5	2D.21	36 x 18
End	M4-6	2D.22	36 x 18
Temporary	M4-7,7a	2D.24	36 x 18
Begin	M4-14	2D.23	36 x 18
Advance Turn Arrow	M5-1,2,3	2D.26	30 x 21
Lane Designation	M5-4,5,6	2D.27	36 x 24
Directional Arrow	M6-1,2,2a,3,4,5,6,7	2D.28	30 x 21
Destination (1 line)	D1-1	2D.37	Varies x 30
Destination and Distance (1 line)	D1-1a	2D.37	Varies x 30
Destination (2 lines)	D1-2	2D.37	Varies x 54
Destination and Distance (2 lines)	D1-2a	2D.37	Varies x 54
Destination (3 lines)	D1-3	2D.37	Varies x 72
Destination and Distance (3 lines)	D1-3a	2D.37	Varies x 72
Distance (1 line)	D2-1	2D.41	Varies x 30
Distance (2 lines)	D2-2	2D.41	Varies x 54
Distance (3 lines)	D2-3	2D.41	Varies x 72
Street Name	D3-1,1a	2D.43	Varies x 18
Advance Street Name (2 lines)	D3-2	2D.44	Varies x 42*
Advance Street Name (3 lines)	D3-2	2D.44	Varies x 66*
Advance Street Name (4 lines)	D3-2	2D.44	Varies x 84*
Park - Ride	D4-2	2D.48	36 x 48
National Scenic Byways	D6-4	2D.55	24 x 24
National Scenic Byways	D6-4a	2D.55	24 x 12
Weigh Station XX Miles	D8-1	2E.54	96 x 72 (F) 78 x 60 (E)
Weigh Station Next Right	D8-2	2E.54	108 x 90 (F) 84 x 72 (E)
Weigh Station (with arrow)	D8-3	2E.54	84 x 78 (F) 66 x 60 (E)
Crossover	D13-1,2	2D.54	78 x 42
Freeway Entrance	D13-3	2D.46	48 x 30
Freeway Entrance (with arrow)	D13-3a	2D.46	48 x 42
Combination Lane Use / Destination	D15-1	2D.33	Varies x 96
Next Truck Lane XX Miles	D17-1	2D.51	60 x 66
Truck Lane XX Miles	D17-2	2D.51	60 x 54
Slow Vehicle Turn-Out XX Miles	D17-7	2D.52	96 x 54

\* The size shown is for a typical sign as illustrated in the figures in Chapters 2D and 2E. The size should be determined based on the amount of legend required for the sign.

\*\* The width shown represents the minimum dimension. The width shall be increased as appropriate to match the width of the guide sign.

- Notes: 1. Larger signs may be used when appropriate  
 2. Dimensions in inches are shown as width x height  
 3. Where two sizes are shown, the larger size is for freeways (F) and the smaller size is for expressways (E)



## Guide - Controlled Access

**Table 2E-2. Minimum Letter and Numeral Sizes for Expressway Guide Signs According to Interchange Classification**

Type of Sign	Type of Interchange (see Section 2E.32)				Overhead
	Major		Intermediate	Minor	
	Category a	Category b			
<b>A. Advance Guide, Exit Direction, and Overhead Guide Signs</b>					
Exit Number Plaques					
Words	10	10	10	8	10
Numerals & Letters	15	15	15	12	15
Interstate Route Signs					
Numerals	18	—	—	—	18
1- or 2-Digit Shields	36 x 36	—	—	—	36 x 36
3-Digit Shields	45 x 36	—	—	—	45 x 36
U.S. or State Route Signs					
Numerals	18	18	18	12	18
1- or 2-Digit Shields	36 x 36	36 x 36	36 x 36	24 x 24	36 x 36
3-Digit Shields	45 x 36	45 x 36	45 x 36	30 x 24	45 x 36
U.S. or State Route Text Identification (Example: US 56)					
Numerals & Letters	18	15	15	12	15
Cardinal Directions					
First Letters	18	15	12	10	15
Rest of Words	15	12	10	8	12
Auxiliary and Alternative Route Legends (Examples: JCT, TO, ALT, BUSINESS)					
Words	15	12	10	8	12
Names of Destinations					
Upper-Case Letters	20	16	13.33	10.67	16
Lower-Case Letters	15	12	10	8	12
Distance Numbers	18	15	12	10	15
Distance Fraction Numerals	12	10	10	8	10
Distance Words	12	10	10	8	10
Action Message Words	10	10	10	8	10
<b>B. Gore Signs</b>					
Words	10	10	10	8	—
Numerals & Letters	12	12	12	10	—

Note: Sizes are shown in inches and where applicable are shown as width x height



**Table 2E-3. Minimum Letter and Numeral Sizes for Expressway Guide Signs According to Sign Type**

Type of Sign	Minimum Size
<b>A. Pull-Through Signs</b>	
Destinations — Upper-Case Letters	13.33
Destinations — Lower-Case Letters	10
Route Signs	
1- or 2-Digit Shields	36 x 36
3-Digit Shields	45 x 36
Cardinal Directions — First Letters	12
Cardinal Directions — Rest of Word	10
<b>B. Supplemental Guide Signs</b>	
Exit Number — Words	8
Exit Number — Numerals and Letters	12
Place Names — Upper-Case Letters	10.67
Place Names — Lower-Case Letters	8
Action Messages	8
Route Signs	
Numerals	12
1- or 2-Digit Shield	24 x 24
3-Digit Shield	30 x 24
<b>C. Interchange Sequence or Community Interchanges Identification Signs</b>	
Words — Upper-Case Letters	10.67
Words — Lower-Case Letters	8
Numerals	10.67
Fraction Numerals	8
Route Signs	
Numerals	12
1- or 2-Digit Shield	24 x 24
3-Digit Shield	30 x 24
<b>D. Next XX Exits Sign</b>	
Place Names — Upper-Case Letters	10.67
Place Names — Lower-Case Letters	8
NEXT XX EXITS — Words	8
NEXT XX EXITS — Number	12

Type of Sign	Minimum Size
<b>E. Distance Signs</b>	
Words — Upper-Case Letters	8
Words — Lower-Case Letters	6
Numerals	8
Route Signs	
Numerals	9
1- or 2-Digit Shield	18 x 18
3-Digit Shield	22.5 x 18
<b>F. General Services Signs (see Chapter 2I)</b>	
Exit Number — Words	8
Exit Number — Numerals and Letters	12
Services	8
<b>G. Rest Area, Scenic Area, and Roadside Area Signs (see Chapter 2I)</b>	
Words	10
Distance Numerals	12
Distance Fraction Numerals	8
Distance Words	8
Action Message Words	10
<b>H. Reference Location Signs (see Chapter 2H)</b>	
Words	4
Numerals	10
<b>I. Boundary and Orientation Signs (see Chapter 2H)</b>	
Words — Upper-Case Letters	8
Words — Lower-Case Letters	6
<b>J. Next Exit and Next Services Signs</b>	
Words and Numerals	8
<b>K. Exit Only Signs</b>	
Words	12
<b>L. Overhead Arrow-Per-Lane and Diagrammatic Signs</b>	
See Table 2E-5	

Note: Sizes are shown in inches and where applicable are shown as width x height





**Table 2E-4. Minimum Letter and Numeral Sizes for Freeway Guide Signs According to Interchange Classification**

Type of Sign	Type of Interchange (see Section 2E.32)				Overhead
	Major		Intermediate	Minor	
	Category a	Category b			
<b>A. Advance Guide, Exit Direction, and Overhead Guide Signs</b>					
Exit Number Plaques					
Words	10	10	10	10	10
Numerals & Letters	15	15	15	15	15
Interstate Route Signs					
Numerals	24/18	—	—	—	18
1- or 2-Digit Shields	48 x 48/ 36 x 36	—	—	—	36 x 36
3-Digit Shields	60 x 48/ 45 x 36	—	—	—	45 x 36
U.S. or State Route Signs					
Numerals	24/18	18	18	12	18
1- or 2-Digit Shields	48 x 48/ 36 x 36	36 x 36	36 x 36	24 x 24	36 x 36
3-Digit Shields	60 x 48/ 45 x 36	45 x 36	45 x 36	30 x 24	45 x 36
U.S. or State Route Text Identification (Example: US 56)					
Numerals & Letters	18	18/15	15	12	15
Cardinal Directions					
First Letters	18	15	15	10	15
Rest of Words	15	12	12	8	12
Auxiliary and Alternative Route Legends (Examples: JCT, TO, ALT, BUSINESS)					
Words	15	12	12	8	12
Names of Destinations					
Upper-Case Letters	20	20	16	13.33	16
Lower-Case Letters	15	15	12	10	12
Distance Numbers	18	18/15	15	12	15
Distance Fraction Numerals	12	12/10	10	8	10
Distance Words	12	12/10	10	8	10
Action Message Words	12	12/10	10	8	10
<b>B. Gore Signs</b>					
Words	12	12	12	8	—
Numerals & Letters	18	18	18	12	—

Notes: 1. Sizes are shown in inches and where applicable are shown as width x height  
 2. Slanted line (/) signifies separation of desirable and minimum sizes





**Guide - Controlled Access**  
**Table 2E-4. Minimum Letter and Numeral Sizes for Freeway**  
**Guide Signs According to Interchange Classification**

Type of Sign	Type of Interchange (see Section 2E.32)				Overhead
	Major		Intermediate	Minor	
	Category a	Category b			
<b>A. Advance Guide, Exit Direction, and Overhead Guide Signs</b>					
Exit Number Plaques					
Words	10	10	10	10	10
Numerals & Letters	15	15	15	15	15
Interstate Route Signs					
Numerals	24/18	—	—	—	18
1- or 2-Digit Shields	48 x 48/ 36 x 36	—	—	—	36 x 36
3-Digit Shields	60 x 48/ 45 x 36	—	—	—	45 x 36
U.S. or State Route Signs					
Numerals	24/18	18	18	12	18
1- or 2-Digit Shields	48 x 48/ 36 x 36	36 x 36	36 x 36	24 x 24	36 x 36
3-Digit Shields	60 x 48/ 45 x 36	45 x 36	45 x 36	30 x 24	45 x 36
U.S. or State Route Text Identification (Example: US 56)					
Numerals & Letters	18	18/15	15	12	15
Cardinal Directions					
First Letters	18	15	15	10	15
Rest of Words	15	12	12	8	12
Auxiliary and Alternative Route Legends (Examples: JCT, TO, ALT, BUSINESS)					
Words	15	12	12	8	12
Names of Destinations					
Upper-Case Letters	20	20	16	13.33	16
Lower-Case Letters	15	15	12	10	12
Distance Numbers	18	18/15	15	12	15
Distance Fraction Numerals	12	12/10	10	8	10
Distance Words	12	12/10	10	8	10
Action Message Words	12	12/10	10	8	10
<b>B. Gore Signs</b>					
Words	12	12	12	8	—
Numeral & Letters	18	18	18	12	—

Notes: 1. Sizes are shown in inches and where applicable are shown as width x height  
2. Slanted line (/) signifies separation of desirable and minimum sizes





Chapter 2E  
 Guide - Controlled Access  
**E11-1 panels**

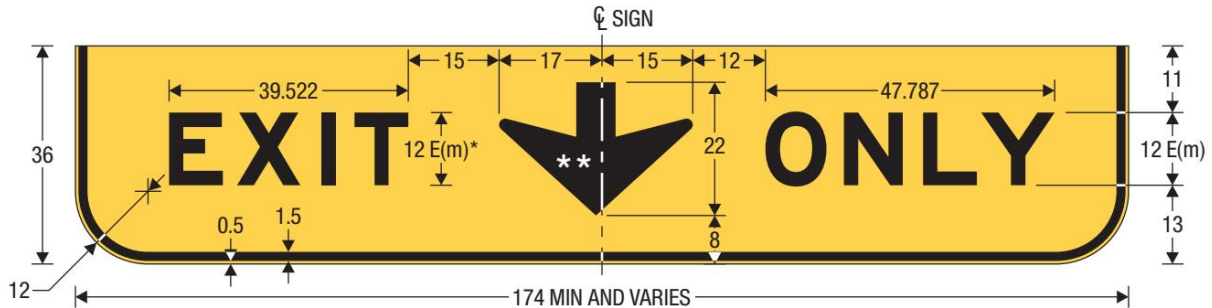

**E11-1**  
 EXIT ONLY (DOWN ARROW)

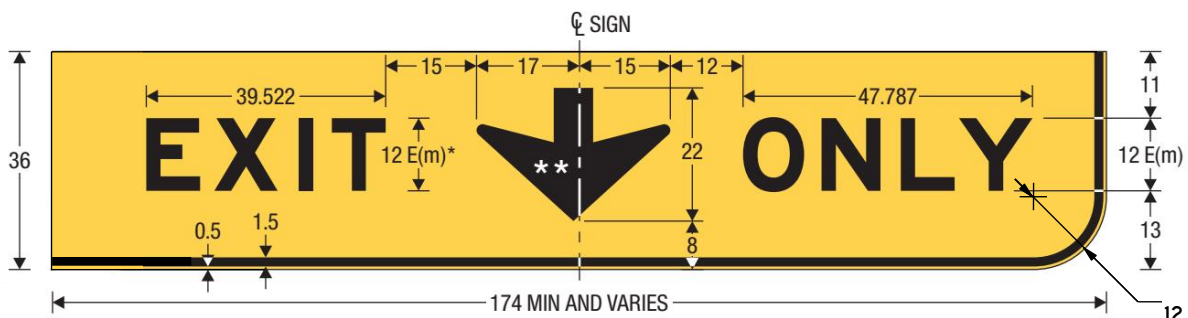

**E11-1R**

EXIT ONLY (DOWN ARROW)

NOTE: E11-1L would be for left lane exit.

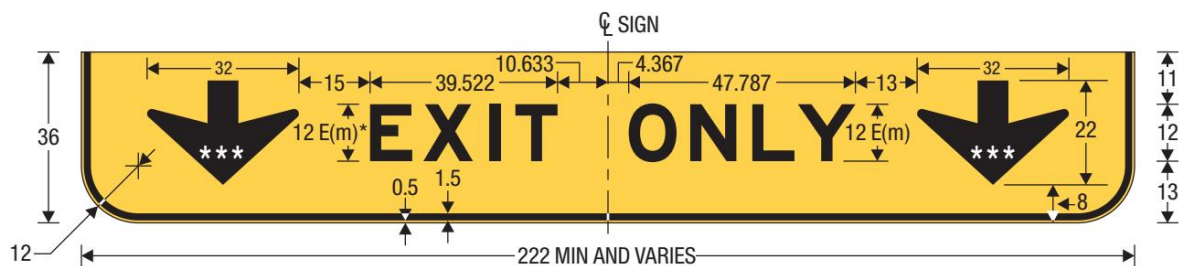

**E11-1f**

EXIT ONLY (2 DOWN ARROWS)

**Colors: LEGEND and BORDER - Black**  
**BACKGROUND - Fluorescent Yellow Reflective**  
**NOTE: Legend and Border to be silk screened, not film.**



# E11-1 panels

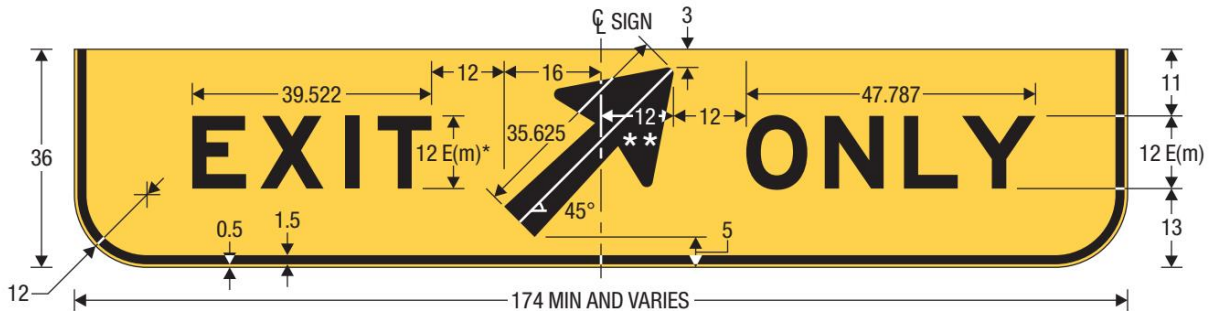

E11-1d  
EXIT ONLY (EXIT DIRECTION)

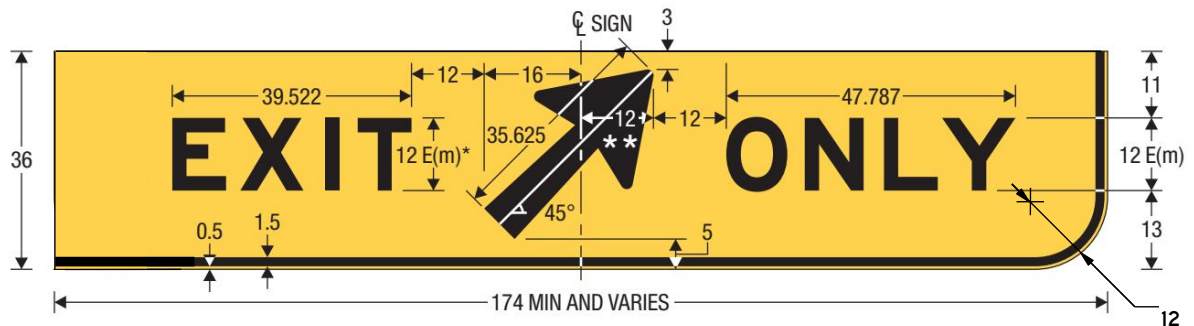

E11-1dR  
EXIT ONLY (EXIT DIRECTION)

NOTE: E11-1dL would be for left lane exit.

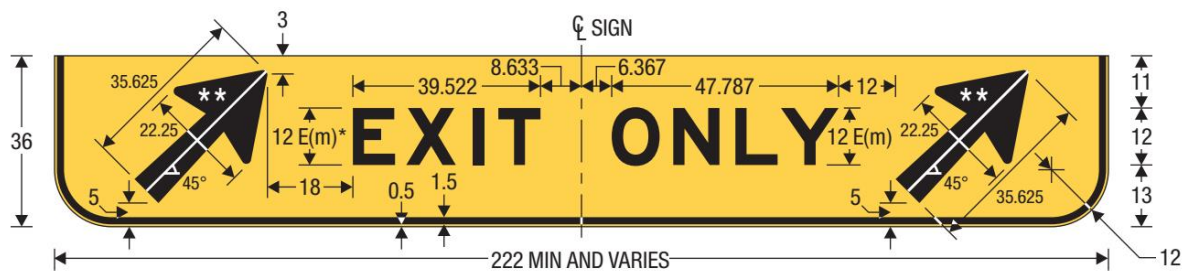

E11-1e  
EXIT ONLY (EXIT DIRECTION)

Colors: LEGEND and BORDER - Black  
BACKGROUND - Fluorescent Yellow Retroreflective  
NOTE: Legend and Border to be silk screened Black, not film.



# 2G - Preferential and Managed Lanes



### Preferential and Managed Lanes

	R3-10		R3-15b		W4-1Lm		E8-1
	R3-11		R3-15c		W4-1Rm		E8-1a
	R3-11c				W4-2Lm		E8-2
	R3-11P				W4-2Rm		E8-2a
	R3-12				W4-2Rm		E8-3
	R3-12a				W13-2m 20		E8-4
	R3-12b				W13-2m 25		E1-5aP
	R3-12c				W13-2m 30		
	R3-12d				W13-2m 35		
	R3-12e				W13-2m 40		
	R3-13				W13-2m 45		
	R3-13a				W13-2m 50		
	R3-14				W13-2m 55		
	R3-14a				W16-11P		
	R3-14b						
	R3-15						
	R3-15a						





## Preferential and Managed Lanes

### Table 2G-1. Managed and Preferential Lanes Sign and Plaque Minimum Sizes

Sign or Plaque	Sign Designation	Section	Conventional Road		Expressway	Freeway	Oversized
			Single Lane	Multi-Lane			
Preferential Lane Vehicle Occupancy Definition (post-mounted)	R3-10,10a	2G.04	30 x 42	30 x 42	36 x 60	78 x 96	78 x 96
Preferential Lane Periods of Operation (post-mounted)	R3-11 series	2G.05	30 x 42	30 x 42	36 x 60	78 x 96	78 x 96
Motorcycles Allowed (plaque)	R3-11P	2G.03	30 x 15	30 x 15	36 x 18	78 x 36	78 x 36
Preferential Lane Ahead or Ends (post-mounted)	R3-12 series	2G.06	30 x 42	30 x 42	36 x 60	48 x 84	48 x 84
Preferential Lane Vehicle Occupancy Definition (overhead)	R3-13,13a	2G.04	66 x 36	66 x 36	84 x 48	144 x 78	144 x 78
HOV Lane Periods of Operation (overhead)	R3-14,14a,14b	2G.05	72 x 60	72 x 60	96 x 72	144 x 108	144 x 108
Preferential Lane Periods of Operation (overhead)	R3-14c	2G.05	90 x 60	90 x 60	108 x 72	156 x 102	168 x 102
HOV Lane Ahead (overhead)	R3-15	2G.06	66 x 36	66 x 36	84 x 48	102 x 60	102 x 60
HOV Lane Begins XX Miles (overhead)	R3-15a	2G.06	78 x 42	78 x 42	102 x 54	132 x 72	132 x 72
HOV Lane Ends (overhead)	R3-15b,15c	2G.07	66 x 36	66 x 36	84 x 48	102 x 60	102 x 60
Preferential Lane Ahead or Ends (overhead)	R3-15d,15e	2G.07	42 x 36	42 x 36	54 x 48	72 x 60	72 x 60
Priced Managed Lane Vehicle Occupancy Definition (post-mounted)	R3-40	2G.17	—	—	54 x 66	54 x 66	66 x 78
Priced Managed Lane Ends (post-mounted)	R3-42,42b	2G.17	—	—	48 x 60	48 x 60	60 x 78
Priced Managed Lane Ends Advance (post-mounted)	R3-42a,42c	2G.17	—	—	48 x 66	48 x 66	60 x 84
Priced Managed Lane Vehicle Occupancy Definition	R3-43	2G.17	—	—	138 x 66	138 x 66	—
Priced Managed Lane Periods of Operation (overhead)	R3-44	2G.17	—	—	90 x 84	90 x 84	—
Priced Managed Lane Periods of Operation (overhead)	R3-44a	2G.17	—	—	132 x 84	132 x 84	—
Priced Managed Lane Ends (overhead)	R3-45	2G.17	—	—	90 x 66	90 x 66	—
Priced Managed Lane Ends (overhead)	R3-45a	2G.17	—	—	114 x 66	114 x 66	—
Priced Managed Lane Toll Rate	R3-48	2G.17	—	—	Varies	Varies	—
Priced Managed Lane Toll Rate	R3-48a	2G.17	—	—	Varies	Varies	—
HOV (plaque)	W16-11P	2G.09	24 x 12	24 x 12	30 x 18	30 x 18	30 x 18
Preferential Lane Entrance Gore	E8-1	2G.10	—	—	48 x 96	48 x 96	—
Preferential Lane Intermediate Entrance Gore	E8-1a	2G.10	—	—	48 x 84	48 x 84	—
Preferential Lane Entrance Direction (overhead)	E8-2	2G.11	—	—	222 x 72	222 x 72	—
Preferential Lane Entrance Direction (post-mounted)	E8-2a	2G.11	—	—	186 x 108	186 x 108	—
Preferential Lane Entrance Advance	E8-3	2G.11	—	—	186 x 96	186 x 96	—
Preferential Lane Direct Exit Gore	E8-4	2G.15	—	—	60 x 78	60 x 78	—
Preferential Lane Intermediate Egress Direction	E8-5	2G.13	—	—	Varies x 90	Varies x 90	—
Preferential Lane Intermediate Egress Advance	E8-6	2G.13	—	—	Varies x 84	Varies x 84	—

Notes: 1. Larger signs may be used when appropriate  
 2. Dimensions in inches are shown as width x height



# 2H - General Information



### General Information

SIGNALS SET FOR 25 M.P.H. I1-1 25

Nevada STATE LINE I-2

 M5-1L G

Saint Viator Community Center I-90

SIGNALS SET FOR 30 M.P.H. I1-1 30

Colorado River I-3

 M5-1R G

LAS VEGAS CONVENTION CENTER I-99

SIGNALS SET FOR 35 M.P.H. I1-1 35

ENTERING Clark County I-4

 M5-2L G

 I-5

 M5-2R G

SIGNALS SET FOR 40 M.P.H. I1-1 40

 I-6

 M6-1 G

SIGNALS SET FOR 45 M.P.H. I1-1 45

 I-7

 M6-2L G

 I-8

 M6-2R G

 RECYCLING COLLECTION CENTER I-11

 M6-3 G

 I-12







### General Information

	D10-4 1E		D10-4 1W		D10-4 12E		D10-4 12W
	D10-4 2E		D10-4 2W		D10-4C 13E		D10-4C 13W
	D10-4 3E		D10-4 3W		D10-4C 14E		D10-4C 14W
	D10-4 4E		D10-4 4W		D10-4C 15E		D10-4C 15W
	D10-4 5E		D10-4 5W		D10-4C 16E		D10-4C 16W
	D10-4 6E		D10-4 6W		D10-4C 17E		D10-4C 17W
	D10-4 7E		D10-4 7W		D10-4C 18E		D10-4C 18W
	D10-4 8E		D10-4 8W		D10-4C 19S		D10-4C 19N
	D10-4 9E		D10-4 9W		D10-4C 20S		D10-4C 20N
	D10-4 10E		D10-4 10W		D10-4C 21S		D10-4C 21N
	D10-4 11E		D10-4 11W		D10-4C 22S		D10-4C 22N



### General Information

	D10-4C 23S		D10-4C 23N		D10-4C 34S		D10-4C 34N
	D10-4C 24S		D10-4C 24N		D10-4C 35S		D10-4C 35N
	D10-4C 25S		D10-4C 25N		D10-4C 36W		D10-4C 36E
	D10-4C 26S		D10-4C 26N		D10-4C 37W		D10-4C 37E
	D10-4C 27S		D10-4C 27N		D10-4C 38W		D10-4C 38E
	D10-4C 28S		D10-4C 28N		D10-4C 39W		D10-4C 39E
	D10-4C 29S		D10-4C 29N		D10-4C 40W		D10-4C 40E
	D10-4C 30S		D10-4C 30N		D10-4C 41W		D10-4C 41E
	D10-4C 31S		D10-4C 31N		D10-4C 42W		D10-4C 42E
	D10-4C 32S		D10-4C 32N		D10-4C 43W		D10-4C 43E
	D10-4C 33S		D10-4C 33N		D10-4C 44W		D10-4C 44E



### General Information



D10-4C 45W



D10-4C 45E



D10-1 X



D10-4C 46W



D10-4C 46E



D10-2 XX



D10-4C 47W



D10-4C 47E



D10-3 XXX



D10-4C 48W



D10-4C 48E



D14-2A



D10-4C 49W



D10-4C 49E



D14-2aP



D10-4C 50W



D10-4C 50E



D10-4C 51W



D10-4C 51E





## CHAPTER 2H. GENERAL INFORMATION SIGNS

### Section 2H.01 Sizes of General Information Signs

**Standard:**

- 01 Except as provided in Section 2A.11, the sizes of General Information signs that have a standardized design shall be as shown in Table 2H-1.

**Support:**

- 02 Section 2A.11 contains information regarding the applicability of the various columns in Table 2H-1.

**Option:**

- 03 Signs larger than those shown in Table 2H-1 may be used (see Section 2A.11).

### Section 2H.02 General Information Signs (I Series)

**Support:**

- 01 Of interest to the traveler, though not directly necessary for guidance, are numerous kinds of information that can properly be conveyed by General Information signs (see Figure 2H-1) or miscellaneous information signs (see Section 2H.04). They include such items as State lines, city limits, other political boundaries, time zones, stream names, elevations, landmarks, and similar items of geographical interest, and safety and transportation-related messages. Chapter 2M contains recreational and cultural interest area symbol signs that are sometimes used in combination with General Information signs.

**Guidance:**

- 02 *General Information signs should not be installed within a series of guide signs or at other equally critical locations, unless there are specific reasons for orienting the road user or identifying control points for activities that are clearly in the public interest. On all such signs, the designs should be simple and dignified, devoid of any advertising, and in general compliance with other guide signing.*

**Table 2H-1. General Information Sign Sizes**

Sign	Sign Designation	Section	Conventional Road	Freeway or Expressway
Reference Location (1 digit)	D10-1	2H.05	10 x 18	12 x 24
Intermediate Reference Location (2 digits)	D10-1a	2H.05	10 x 27	12 x 36
Reference Location (2 digits)	D10-2	2H.05	10 x 27	12 x 36
Intermediate Reference Location (3 digits)	D10-2a	2H.05	10 x 36	12 x 48
Reference Location (3 digits)	D10-3	2H.05	10 x 36	12 x 48
Intermediate Reference Location (4 digits)	D10-3a	2H.05	10 x 48	12 x 60
Enhanced Reference Location	D10-4	2H.06	18 x 54	18 x 54
Intermediate Enhanced Reference Location	D10-5	2H.06	18 x 60	18 x 60
Acknowledgement	D14-1	2H.08	36 x 30*	72 x 48*
Acknowledgement	D14-2	2H.08	36 x 30*	72 x 48*
Acknowledgement	D14-3	2H.08	42 x 24*	96 x 36*
Signals Set for XX MPH	I1-1	2H.03	24 x 36	—
Jurisdictional Boundary	I-2	2H.04	Varies x 18**	Varies x 36**
Geographical Features	I-3	2H.04	Varies x 18**	Varies x 36**
Airport	I-5	2H.02	24 x 24	30 x 30
Bus Station	I-6	2H.02	24 x 24	30 x 30
Train Station	I-7	2H.02	24 x 24	30 x 30
Library	I-8	2H.02	24 x 24	30 x 30
Vehicle Ferry Terminal	I-9	2H.02	24 x 24	30 x 30
Recycling Collection Center	I-11	2H.02	30 x 48	—
Light Rail Transit Station	I-12	2H.02	24 x 24	—

\* The size shown is the maximum size for the corresponding roadway classification. The size of the sign and acknowledgement logo should be appropriately reduced where shorter legends are used.

\*\* The size shown is for the typical sign illustrated in the figure. The size should be determined based on the amount of legend required for the sign.

Notes: 1. Larger signs may be used when appropriate, except for the D14 series signs  
2. Dimensions in inches are shown as width x height



# 21 - General Services





D9-1



D9-2



D9-3



D9-3a



D9-4



D9-5



D9-6P



D9-7



D9-8



D9-9



D9-10



D9-11



D9-11a



D9-11b



D9-11bP



D9-11c



D9-12



D9-13



D9-13aP



D9-13bP



D9-13cP



D9-13dP



D9-14



D9-15



D9-16



D9-20



D9-20aP



D9-21



D9-22



D9-17p XX



M5-1L



M5-1R



M5-2L



M5-2R



M5-3



M5-4



M5-5



M5-6



M6-1



M6-2L



M6-2R















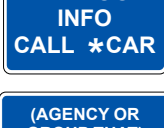

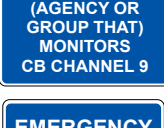







M6-2L

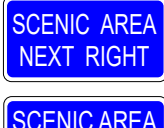
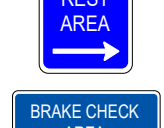

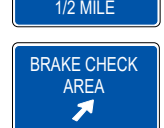
M6-2R

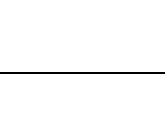
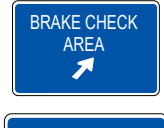
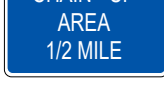

<b>EXIT 1</b>	E1-5Pb 1	<b>EXIT 33</b>	E1-5Pb 33		D9-18		D5-16
<b>EXIT 2</b>	E1-5Pb 2	<b>EXIT 35</b>	E1-5Pb 35		D9-18a		D12-1
<b>EXIT 3A</b>	E1-5Pb 3A	<b>EXIT 37</b>	E1-5Pb 37		D9-18b (XX)		D12-2
<b>EXIT 3B</b>	E1-5Pb 3B	<b>EXIT 38A</b>	E1-5Pb 38A		D9-18b NR		D12-3
<b>EXIT 5</b>	E1-5Pb 5	<b>EXIT 38B</b>	E1-5Pb 38B		D9-18c (XX)		D12-4
<b>EXIT 6</b>	E1-5Pb 6	<b>EXIT 40</b>	E1-5Pb 40		D9-18c NR		D12-5
<b>EXIT 7</b>	E1-5Pb 7	<b>EXIT 41</b>	E1-5Pb 41		D9-18c NR		D12-5a
<b>EXIT 8</b>	E1-5Pb 8	<b>EXIT 43</b>	E1-5Pb 43		D5-1		D6-1
<b>EXIT 9</b>	E1-5Pb 9	<b>EXIT 45</b>	E1-5Pb 45		D5-1a		D6-1a
<b>EXIT 10</b>	E1-5Pb 10	<b>EXIT 46</b>	E1-5Pb 46		D5-2		D6-2
<b>EXIT 11</b>	E1-5Pb 11	<b>EXIT 47</b>	E1-5Pb 47		D5-2a		D6-2a
<b>EXIT 12A</b>	E1-5Pb 12A	<b>EXIT 48</b>	E1-5Pb 48		D5-5		D6-5
<b>EXIT 12B</b>	E1-5Pb 12B	<b>EXIT 49</b>	E1-5Pb 49		D5-13		
<b>EXIT 13</b>	E1-5Pb 13	<b>EXIT 50</b>	E1-5Pb 50		D5-14		
<b>EXIT 14</b>	E1-5Pb 14	<b>EXIT 51</b>	E1-5Pb 1		D5-15		
<b>EXIT 15</b>	E1-5Pb 15						
<b>EXIT 16</b>	E1-5Pb 16						
<b>EXIT 17</b>	E1-5Pb 17						
<b>EXIT 18</b>	E1-5Pb 18						
<b>EXIT 19</b>	E1-5Pb 19						
<b>EXIT 20</b>	E1-5Pb 20						
<b>EXIT 21</b>	E1-5Pb 21						
<b>EXIT 23</b>	E1-5Pb 23						
<b>EXIT 25</b>	E1-5Pb 25						
<b>EXIT 26</b>	E1-5Pb 26						
<b>EXIT 27</b>	E1-5Pb 27						
<b>EXIT 28</b>	E1-5Pb 28						
<b>EXIT 29</b>	E1-5Pb 29						
<b>EXIT 30</b>	E1-5Pb 30						
<b>EXIT 32</b>	E1-5Pb 32						



Chapter 21  
 Service  
 NDOT - Service



GNV30-1



GNV30-2



GNV39-1



GNV39-2L



GNV39-2R



GNV39-6



GNV39-7L



GNV39-7R

**NDOT Signs Sizes**

Type	Code	W	H
GNV	30 - 1	114 x 60	
GNV	30 - 2	120 x 60	
GNV	39 - 1	96 x 30	
GNV	39 - 2	78 x 36	
GNV	39 - 6	36 x 18	
GNV	39 - 7	24 x 30	



## Service

## CHAPTER 21. GENERAL SERVICE SIGNS

Section 21.01 Sizes of General Service Signs**Standard:**

- 01 Except as provided in Section 2A.11, the sizes of General Service signs that have a standardized design shall be as shown in Table 2I-1.

**Support:**

- 02 Section 2A.11 contains information regarding the applicability of the various columns in Table 2I-1.

**Option:**

- 03 Signs larger than those shown in Table 2I-1 may be used (see Section 2A.11).

Table 2I-1. General Service Sign and Plaque Sizes (Sheet 1 of 2)

Sign or Plaque	Sign Designation	Section	Conventional Road	Freeway or Expressway
Rest Area XX Miles	D5-1	21.05	66 x 36*	96 x 54*
Rest Area Next Right	D5-1a	21.05	78 x 36*	120 x 60* (F) 114 x 48* (E)
Rest Area (with arrow)	D5-2	21.05	66 x 36*	96 x 54*
Rest Area Gore	D5-2a	21.05	42 x 48*	78 x 78* (F) 66 x 72* (E)
Rest Area (with horizontal arrow)	D5-5	21.05	42 x 48*	—
Next Rest Area XX Miles	D5-6	21.05	60 x 48*	90 x 72*
Rest Area Tourist Info Center XX Miles	D5-7	21.08	90 x 72*	114 x 102* (F) 132 x 96* (E)
Rest Area Tourist Info Center (with arrow)	D5-8	21.08	84 x 72*	120 x 102* (F) 120 x 96* (E)
Rest Area Tourist Info Center Next Right	D5-11	21.08	90 x 72*	144 x 102* (F) 132 x 96* (E)
Interstate Oasis	D5-12	21.04	—	156 x 78
Interstate Oasis (plaque)	D5-12P	21.04	—	114 x 48
Brake Check Area XX Miles	D5-13	21.06	84 x 48	126 x 72
Brake Check Area (with arrow)	D5-14	21.06	78 x 60	96 x 72
Chain-Up Area XX Miles	D5-15	21.07	66 x 48	96 x 72
Chain-Up Area (with arrow)	D5-16	21.07	72 x 54	96 x 66
Telephone	D9-1	21.02	24 x 24	30 x 30
Hospital	D9-2	21.02	24 x 24	30 x 30
Camping	D9-3	21.02	24 x 24	30 x 30
Trailer Camping	D9-3a	21.02	24 x 24	30 x 30
Litter Container	D9-4	21.02	24 x 30	36 x 48
Handicapped	D9-6	21.02	24 x 24	30 x 30
Van Accessible (plaque)	D9-6P	21.02	18 x 9	—
Gas	D9-7	21.02	24 x 24	30 x 30
Food	D9-8	21.02	24 x 24	30 x 30
Lodging	D9-9	21.02	24 x 24	30 x 30
Tourist Information	D9-10	21.02	24 x 24	30 x 30
Diesel Fuel	D9-11	21.02	24 x 24	30 x 30
Alternative Fuel - Compressed Natural Gas	D9-11a	21.02	24 x 24	30 x 30
Electric Vehicle Charging	D9-11b	21.02	24 x 24	30 x 30
Electric Vehicle Charging (plaque)	D9-11bP	21.02	24 x 18	30 x 24
Alternative Fuel - Ethanol	D9-11c	21.02	24 x 24	30 x 30
RV Sanitary Station	D9-12	21.02	24 x 24	30 x 30
Emergency Medical Services	D9-13	21.02	24 x 24	30 x 30





## Service

Table 21-1. General Service Sign and Plaque Sizes (Sheet 2 of 2)

Sign or Plaque	Sign Designation	Section	Conventional Road	Freeway or Expressway
Hospital (plaque)	D9-13aP	21.02	24 x 12	30 x 12
Ambulance Station (plaque)	D9-13bP	21.02	24 x 12	30 x 15
Emergency Medical Care (plaque)	D9-13cP	21.02	24 x 18	30 x 24
Trauma Center (plaque)	D9-13dP	21.02	24 x 12	30 x 15
Police	D9-14	21.02	24 x 24	30 x 30
Propane Gas	D9-15	21.02	24 x 24	30 x 30
Truck Parking	D9-16	21.02	24 x 24	30 x 30
Next Services XX Miles (plaque)	D9-17P	21.02	102 x 24	156 x 30
General Services (up to 6 symbols)	D9-18	21.03	—	96 x 60
General Services	D9-18a	21.03	—	96 x 60
General Services (up to 6 symbols) with Action or Exit Information	D9-18b	21.03	108 x 84	132 x 114 (F) 132 x 108 (E)
General Services with Action or Exit Information	D9-18c	21.03	72 x 60**	132 x 108** (F) 108 x 84** (E)
Pharmacy	D9-20	21.02	24 x 24	30 x 30
24-Hour (plaque)	D9-20aP	21.02	24 x 12	30 x 12
Telecommunication Device for the Deaf	D9-21	21.05	24 x 24	30 x 30
Wireless Internet	D9-22	21.05	24 x 24	30 x 30
Weather Information	D12-1	21.09	84 x 48	132 x 84
Carpool Information	D12-2	21.11	60 x 42	96 x 66
Channel 9 Monitored	D12-3	21.09	84 x 48	132 x 84
Emergency Call 911	D12-4	21.09	66 x 30	96 x 48
Travel Info Call 511 (pictograph)	D12-5	21.10	42 x 60	66 x 78
Travel Info Call 511	D12-5a	21.10	48 x 36	66 x 48

\* The size shown is for a sign with a REST AREA and/or TOURIST INFO CENTER legend. The size should be appropriately adjusted if an alternate legend is used.

\*\* The size shown is for a sign with four lines of services. The size should be appropriately adjusted depending on the amount of legend displayed.

Notes: 1. Larger signs may be used when appropriate  
2. Dimensions in inches are shown as width x height  
3. Where two sizes are shown, the larger size is for freeways (F) and the smaller size is for expressways (E)

## Section 21.02 General Service Signs for Conventional Roads

Support:

- 01 On conventional roads, commercial services such as gas, food, and lodging generally are within sight and are available to the road user at reasonably frequent intervals along the route. Consequently, on this class of road there usually is no need for special signs calling attention to these services. Moreover, General Service signing is usually not required in urban areas except for hospitals, law enforcement assistance, tourist information centers, and camping.

Option:

- 02 General Service signs (see Figure 21-1) may be used where such services are infrequent and are found only on an intersecting highway or crossroad.

**Standard:**

- 03 **All General Service signs and supplemental sign panels shall have white letters, symbols, arrows, and borders on a blue background.**

*Guidance:*

- 04 *General Service signs should be installed at a suitable distance in advance of the turn-off point or intersecting highway.*

- 05 *States that elect to provide General Service signing should establish a statewide policy or warrant for its use, and criteria for the availability of services. Local jurisdictions electing to use such signing should follow State policy for the sake of uniformity.*

Option:

- 06 Individual States may sign for whatever alternative fuels are available at appropriate locations.



# 2M - Recreational and Cultural Interest Area



Chapter 2M  
Recreational



RS-002



RS-023



RS-044



RS-060



RS-005



RS-024



RS-045



RS-061



RS-006



RS-026



RS-046



RS-062



RS-007



RS-027



RS-047



RS-063



RS-008



RS-030



RS-048



RS-064



RS-009



RS-031



RS-049



RS-067



RS-010



RS-034



RS-050



RS-068



RS-011



RS-035



RS-052



RS-070



RS-012



RS-036



RS-053



RS-071



RS-013



RS-037



RS-054



RS-073



RS-015



RS-039



RS-055



RS-076



RS-017



RS-040



RS-056



RS-077



RS-020



RS-041



RS-057



RS-078



RS-021



RS-042



RS-058



RS-079



RS-022



RS-043



RS-059



RS-080





RS-081



RS-096



RS-113



RS-128



RS-082



RS-097



RS-114



RS-129



RS-083



RS-098



RS-115



RS-137



RS-084



RS-099



RS-116



RS-138



RS-085



RS-101



RS-117



RS-140



RS-086



RS-102



RS-118



RS-141



RS-087



RS-103



RS-119



RS-142



RS-088



RS-104



RS-120



RS-143



RS-089



RS-105



RS-121



RS-144



RS-090



RS-106



RS-122



RS-145



RS-091



RS-107



RS-123



RS-146



RS-092



RS-108



RS-124



RS-147



RS-093



RS-109



RS-125



RS-148



RS-094



RS-111



RS-126



RS-149



RS-095



RS-112



RS-127



RS-150





RS-200



D7-1 RRC X26



D7-1 RRC 215



D7-1 VOF 12



D7-2 RRC L



D7-2 RRC R



D7-2 WLP L



D7-2 WLP R



M5-1L B



M5-1R B



M5-2L B



M5-2R B



M5-3 B



M5-4 B



M5-5 B



M5-6 B



M6-1 B



M6-2L B



M6-2R B



M6-3 B



Recreational

**Table 2M-1. Category Chart for Recreational and Cultural Interest Area Symbols**

General	
Bear Viewing Area	RS-012
Bus Stop	RS-031
Campfires *	RS-042
Cans or Bottles *	RS-101
Cultural Interest Area	RS-142
Dam	RS-009
Deer Viewing Area	RS-011
Falling Rocks *	RS-008
Fire Extinguisher *	RS-090
Lighthouse	RS-007
Lookout Tower	RS-006
Nature Study Area	RS-141
Pets on Leash *	RS-017
Pick-Up Trucks	RS-140
Point of Interest	RS-080
Radios *	RS-103
Rattlesnakes *	RS-099
Recycling *	RS-200
Sea Plane	RS-115
Smoking *	RS-002
Snack Bar *	RS-102
Stay on Trail *	RS-123
Strollers *	RS-111
Tunnel	RS-005
Viewing Area	RS-036
Walk on Boardwalk *	RS-122
Wood Gathering *	RS-120

Accommodations	
Baby Changing Station (Men's Room)	RS-137
Baby Changing Station (Women's Room)	RS-138
Men's Restroom	RS-021
Parking	RS-034
Recreational Vehicle Site	RS-104
Restrooms	RS-022
Sleeping Shelter *	RS-037
Trailer Site	RS-040
Walk-In Camp	RS-148
Women's Restroom	RS-023

Services	
Drinking Water	RS-013
Electrical Hook-Up	RS-150
Firewood Cutting *	RS-112
First Aid	RS-024
Grocery Store	RS-020
Kennel	RS-045
Laundromat	RS-085
Litter Receptacle	RS-086
Lockers/Storage *	RS-030
Mechanic	RS-027
Picnic Shelter	RS-039
Picnic Site	RS-044
Post Office	RS-026
Ranger Station	RS-015
Sanitary Station	RS-041
Showers *	RS-035
Stable	RS-073
Theater	RS-109
Trail Shelter *	RS-043
Tramway	RS-071
Trash Dumpster	RS-091

Land Recreation	
All-Terrain Trail	RS-095
Amphitheater	RS-070
Archery	RS-116
Baseball *	RS-096
Climbing *	RS-082
Corral	RS-149
Driving Tour	RS-113
Exercise/Fitness	RS-097
Golfing *	RS-128
Hang Gliding	RS-126
Hiking Trail	RS-068
Horse Trail	RS-064
In-Line Skating	RS-125
Interpretive Trail	RS-114
Off-Road Vehicle Trail	RS-067
Rock Collecting *	RS-083
Skateboarding *	RS-098
Spelunking/Caves	RS-084
Technical Rock Climbing	RS-081
Tennis	RS-129
Wildlife Viewing	RS-076

Water Recreation	
Beach	RS-145
Boat Motor	RS-147
Boat Ramp	RS-054
Canoeing	RS-079
Diving	RS-062
Fish Cleaning *	RS-093
Fish Hatchery	RS-010
Fish Ladder *	RS-089
Fishing Area	RS-063
Fishing Pier	RS-119
Hand Launch/Small Boat Launch	RS-117
Jet Ski/Personal Watercraft	RS-121
Kayaking	RS-118
Lifejackets *	RS-094
Marina	RS-053
Motorboating	RS-055
Rafting	RS-146
Rowboating	RS-057
Sailing	RS-056
Scuba Diving	RS-060
Seal Viewing	RS-106
Surfing	RS-059
Swimming	RS-061
Tour Boat	RS-087
Wading	RS-088
Waterskiing	RS-058
Whale Viewing	RS-107
Wind Surfing	RS-108

Winter Recreation	
Chair Lift/Ski Lift	RS-105
Cross Country Skiing	RS-046
Dog Sledding	RS-143
Downhill Skiing	RS-047
Ice Fishing	RS-092
Ice Skating	RS-050
Ski Jumping	RS-048
Sledding	RS-049
Snow Tubing	RS-144
Snowboarding	RS-127
Snowmobiling	RS-052
Snowshoeing	RS-078
Winter Recreational Area	RS-077

\* For non-road use only































# 2N - Emergency Management



# Emergency Management

	EM-2		EM-6aL		EM-7aL (X)
	EM-3		EM-6aS		EM-7aS (X)
	EM-4		EM-6aR		EM-7aR (X)
	EM-5		EM-6bL		EM-7cL (X)
	R1-1		EM-6bS		EM-7cS (X)
			EM-6bR		EM-7cR (X)
			EM-6cL		EM-7dL (X)
			EM-6cS		EM-7dS (X)
			EM-6cR		EM-7dR (X)
			EM-6dL		
			EM-6dS		
			EM-6dR		

**Table 2N-1. Emergency Management Sign Sizes**

Sign or Plaque	Sign Designation	Section	Minimum Size
Evacuation Route	EM-1,EM-1a	2N.03	24 x 24*
Area Closed	EM-2	2N.04	30 x 24
Traffic Control Point	EM-3	2N.05	30 x 24
Maintain Top Safe Speed	EM-4	2N.06	24 x 30
Permit Required	EM-5	2N.07	24 x 30
Emergency Aid Center	EM-6a to EM-6d	2N.08	30 x 24
Shelter Directional	EM-7a to EM-7d	2N.09	30 x 24

\* A minimum size of 18 x 18 may be used on low-volume roadways or roadways with speeds of 25 mph or less

Notes: 1. Larger signs may be used when appropriate  
2. Dimensions in inches are shown as width x height



# 6 - Construction



**Section 6F.03 Sign Placement**

**STANDARD:**











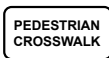

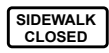

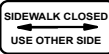

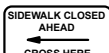

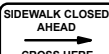

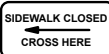
05 The minimum height, measured vertically from the bottom of the sign to the top of the curb, or in the absence of elevation of curb, measured vertically from the bottom of the sign to the elevation of the near edge of the traveled way, of signs installed at the side of the road in business, commercial, or residential areas where parking or pedestrian movements are likely to occur, or where the view of the sign might be obstructed, shall be 7 feet.

06 The minimum height, measured vertically from the bottom of the sign to the sidewalk, of signs installed above sidewalks shall be 7 feet.

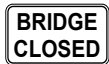
08 Neither portable nor permanent sign supports should be located on sidewalks, bicycle facilities, or areas designated for pedestrian or bicycle traffic. If the bottom of a secondary sign that is mounted below another sign is mounted lower than 7 feet above a pedestrian sidewalk or pathway (see Section 6D.02), the secondary sign should not project more than 4 inches into the pedestrian facility.

11 Except as provided in Paragraph 12, signs mounted on portable sign supports that do not meet the minimum mounting heights provided in Paragraphs 4 through 6 should not be used for a duration of more than 3 days. Option:













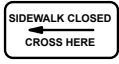
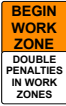

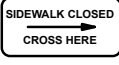
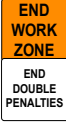































12 The R9-8 through R9-11a series, R11 series, W1-6 through W1-8 series, M4-10, E5-1, or other similar type signs (see Figures 6F-3, 6F-4, and 6F-5) may be used on portable sign supports that do not meet the minimum mounting heights provided in Paragraphs 4 through 6 for longer than 3 days.

	R9-8		W1-6
	R9-9		W1-7
	R9-10		W1-8
	R9-11L		M4-10L
	R9-11R		M4-10R
	R9-11aL		E5-1
	R9-11aR		
	R11-2		
	R11-2b		
	R11-2c		
	R11-2d		
	R11-3a XX		
	R11-3b XX		
	R11-4		



# Chapter 6



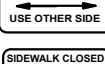
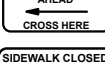
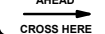















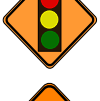





































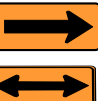

## Construction - Regulatory

	R1-1		R3-18		R9-11aL		R2-98
	R1-2		R3-27		R9-11aR		R2-99
	R1-2aP		R4-1		R11-2		R3-99L
	R1-7		R4-2		R11-2b		R3-99R
	R1-8		R4-7		R11-2c		
	G20-5aP (Install above R2-1)		R4-7c (Narrow Width)		R11-2d		
	R2-1 XX		R4-7c (Narrow Width)		R11-3a XX		
	R3-1		R4-8		R11-3b XX		
	R3-2		R4-8a		R11-4		
	R3-3		R4-8b				
	R3-4		R4-8C (Narrow Width)				
	R3-5L		R4-9				
	R3-5R		R5-1				
	R3-5S		R5-1a				
	R3-6L		R6-1R				
	R3-7L		R6-1L				
	R3-7R		R8-3				
	R3-8L		R9-8				
			R9-9				
			R9-10				
			R9-11L				
			R9-11R				

NOTE: Additional Regulatory sign may be found in Part 2B.

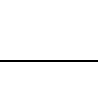
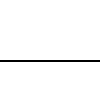
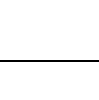
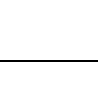









































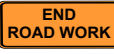

























# Chapter 6 Construction - Warning

	W1-1L		W3-1		W5-3		W8-8
	W1-1R		W3-2		W5-4		W8-9
	W1-2L		W3-3		W6-1		W8-11
	W1-2R		W3-4		W6-2		W8-12
	W1-3L		W3-5 XX		W6-3		W8-15
	W1-3R		W4-1L		W6-4		W8-15P Used only with W8-15
	W1-4L		W4-1R		W7-1		W8-17
	W1-4bL		W4-2L		W7-3aP X		W8-17P Used only with W8-17
	W1-4cL		W4-2R		W8-1		W8-23
	W1-4R		W4-3L		W8-2		W8-24
	W1-4bR		W4-3R		W8-2a		W8-25
	W1-4cR		W4-5P		W8-3		W9-1L
	W1-6		W4-7L		W8-4		W9-1R
	W1-7		W4-7R		W8-5		W9-2L
	W1-8		W5-1		W8-6		W9-2R
			W5-2		W8-7		W9-3





# Chapter 6 Construction - Warning

	W11-10		W21-2		W24-1L		E5-2
	W12-1		W21-2a		W24-1aL		E5-2a
	W12-2 (XX-Y)		W21-3		W24-1bL		E5-3
	W13-1P (XX)		W21-4		W24-1R		M4-8
	W13-4P		W21-5		W24-1aR		M4-8a
	W14-3		W21-5aL		W24-1bR		M4-8b
	W20-1		W21-5aR		G20-1 (X)		M4-9L
	W20-2		W21-5bL		G20-2		M4-9R
	W20-3		W21-5bR		G20-4		M4-9S
	W20-4		W21-6				M4-9aL
	W20-5L		W21-7				M4-9aR
	W20-5R		W21-8				M4-9aS
	W20-5aL		W21-8a				M4-9bL
	W20-5aR		W22-1				M4-9bR
	W20-7		W22-2				M4-9bS
	W16-2P 500		W22-3				M4-9cL
	W21-1		W23-2				M4-9cL
					Type A - Low-Intensity Flashing		M4-9cS
					Type B - High-Intensity Flashing 24 HR		M4-10L
					Type C - Steady Burn		M4-10R
					Type D - 360-degree Steady Burn		



# Chapter 6 Construction - Warning



Type 1 L  
Barricade



Type 1 R  
Barricade



Type 2 L  
Barricade



Type 2 R  
Barricade



Type 3 L  
Barricade



Type 3 R  
Barricade



Type 3 PL  
Barricade



Type 3 PR  
Barricade

Orange and White Striping  
Temporary

Red and White Striping  
Permanent



42" Stacker  
Tangents only

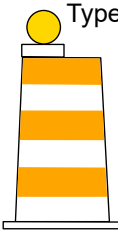

Type C - Steady Burn  
Drum (with light)  
Tapers and Tangents



Table 6F-1. Temporary Traffic Control Zone Sign and Plaque Sizes (Sheet 1 of 3)

Sign or Plaque	Sign Designation	Section	Conventional Road	Freeway or Expressway	Minimum
Stop	R1-1	6F.06	30 x 30*	—	—
Stop (on Stop/Slow Paddle)	R1-1	6E.03	18 x 18	—	—
Yield	R1-2	6F.06	36 x 36 x 36*	—	30 x 30 x 30
To Oncoming Traffic (plaque)	R1-2aP	6F.06	36 x 30	48 x 36	24 x 18
Wait on Stop	R1-7	6E.05	24 x 30	24 x 30	—
Go on Slow	R1-8	6E.05	24 x 30	24 x 30	—
Speed Limit	R2-1	6F.12	24 x 30*	36 x 48	—
Fines Higher (plaque)	R2-6P	6F.12	24 x 18	36 x 24	—
Fines Double (plaque)	R2-6aP	6F.12	24 x 18	36 x 24	—
\$XX Fine (plaque)	R2-6bP	6F.12	24 x 18	36 x 24	—
Begin Higher Fines Zone	R2-10	6F.12	24 x 30	36 x 48	—
End Higher Fines Zone	R2-11	6F.12	24 x 30	36 x 48	—
End Work Zone Speed Limit	R2-12	6F.12	24 x 36	36 x 54	—
Movement Prohibition	R3-1,2,3,4,18,27	6F.06	24 x 24*	36 x 36	—
Mandatory Movement (1 lane)	R3-5	6F.06	30 x 36	—	—
Optional Movement (1 lane)	R3-6	6F.06	30 x 36	—	—
Mandatory Movement (text)	R3-7	6F.06	30 x 30*	—	—
Advance Intersection Lane Control	R3-8	6F.06	Varies x 30	—	—
Do Not Pass	R4-1	6F.06	24 x 30	36 x 48	—
Pass With Care	R4-2	6F.06	24 x 30	36 x 48	—
Keep Right	R4-7	6F.06	24 x 30	36 x 48	—
Narrow Keep Right	R4-7c	6F.06	18 x 30	—	—
Stay in Lane	R4-9	6F.11	24 x 30	36 x 48	—
Do Not Enter	R5-1	6F.06	30 x 30*	36 x 36	—
Wrong Way	R5-1a	6F.06	36 x 24*	42 x 30	—
One Way	R6-1	6F.06	36 x 12*	54 x 18	—
One Way	R6-2	6F.06	24 x 30*	36 x 48	—
No Parking (symbol)	R8-3	6F.06	24 x 24	36 x 36	—
Pedestrian Crosswalk	R9-8	6F.13	36 x 18	—	—
Sidewalk Closed	R9-9	6F.14	24 x 12	—	—
Sidewalk Closed, Use Other Side	R9-10	6F.14	24 x 12	—	—
Sidewalk Closed Ahead, Cross Here	R9-11	6F.14	24 x 18	—	—
Sidewalk Closed, Cross Here	R9-11a	6F.14	24 x 12	—	—
Road Closed	R11-2	6F.08	48 x 30	—	—
Road Closed - Local Traffic Only	R11-3a,3b,4	6F.09	60 x 30	—	—
Weight Limit	R12-1,2	6F.10	24 x 30	36 x 48	—
Weight Limit (with symbols)	R12-5	6F.10	24 x 36	36 x 48	—
Turn and Curve Signs	W1-1,2,3,4	6F.16	36 x 36	48 x 48	30 x 30
Reverse Curve (2 or more lanes)	W1-4b,4c	6F.48	36 x 36	48 x 48	30 x 30
One-Direction Large Arrow	W1-6	6F.16	48 x 24	60 x 30	—
Chevron	W1-8	6F.16	18 x 24	30 x 36	—
Stop Ahead	W3-1	6F.16	36 x 36	48 x 48	30 x 30
Yield Ahead	W3-2	6F.16	36 x 36	48 x 48	30 x 30
Signal Ahead	W3-3	6F.16	36 x 36	48 x 48	30 x 30
Be Prepared to Stop	W3-4	6F.16	36 x 36	48 x 48	30 x 30
Reduced Speed Limit Ahead	W3-5	6F.16	36 x 36	48 x 48	30 x 30



Table 6F-1. Temporary Traffic Control Zone Sign and Plaque Sizes (Sheet 2 of 3)

Sign or Plaque	Sign Designation	Section	Conventional Road	Freeway or Expressway	Minimum
XX MPH Speed Zone Ahead	W3-5a	6F.16	36 x 36	48 x 48	30 x 30
Merging Traffic	W4-1,5	6F.16	36 x 36	48 x 48	36 x 36
Lane Ends	W4-2	6F.24	36 x 36	48 x 48	30 x 30
Added Lane	W4-3,6	6F.16	36 x 36	48 x 48	30 x 30
No Merge Area (plaque)	W4-5P	6F.16	18 x 24	24 x 30	—
Road Narrows	W5-1	6F.16	36 x 36	48 x 48	30 x 30
Narrow Bridge	W5-2	6F.16	36 x 36	48 x 48	30 x 30
One Lane Bridge	W5-3	6F.16	36 x 36	48 x 48	30 x 30
Ramp Narrows	W5-4	6F.26	36 x 36	48 x 48	30 x 30
Divided Highway	W6-1	6F.16	36 x 36	48 x 48	30 x 30
Divided Highway Ends	W6-2	6F.16	36 x 36	48 x 48	30 x 30
Two-Way Traffic	W6-3	6F.32	36 x 36	48 x 48	30 x 30
Two-Way Traffic	W6-4	6F.76	12 x 18	12 x 18	—
Hill (symbol)	W7-1	6F.16	36 x 36	48 x 48	30 x 30
Next XX Miles (plaque)	W7-3aP	6F.53	24 x 18	36 x 30	—
Bump	W8-1	6F.16	36 x 36	48 x 48	30 x 30
Dip	W8-2	6F.16	36 x 36	48 x 48	30 x 30
Pavement Ends	W8-3	6F.16	36 x 36	48 x 48	30 x 30
Soft Shoulder	W8-4	6F.44	36 x 36	48 x 48	30 x 30
Slippery When Wet	W8-5	6F.16	36 x 36	48 x 48	30 x 30
Truck Crossing	W8-6	6F.36	36 x 36	48 x 48	30 x 30
Loose Gravel	W8-7	6F.16	36 x 36	48 x 48	30 x 30
Rough Road	W8-8	6F.16	36 x 36	48 x 48	30 x 30
Low Shoulder	W8-9	6F.44	36 x 36	48 x 48	30 x 30
Uneven Lanes	W8-11	6F.45	36 x 36	48 x 48	30 x 30
No Center Line	W8-12	6F.47	36 x 36	48 x 48	30 x 30
Fallen Rocks	W8-14	6F.16	36 x 36	48 x 48	30 x 30
Grooved Pavement	W8-15	6F.16	36 x 36	48 x 48	30 x 30
Motorcycle (plaque)	W8-15P	6F.54	24 x 18	30 x 24	—
Shoulder Drop Off (symbol)	W8-17	6F.44	36 x 36	48 x 48	30 x 30
Shoulder Drop-Off (plaque)	W8-17P	6F.44	24 x 18	30 x 24	—
Road May Flood	W8-18	6F.16	36 x 36	48 x 48	24 x 24
No Shoulder	W8-23	6F.16	36 x 36	48 x 48	30 x 30
Steel Plate Ahead	W8-24	6F.46	36 x 36	48 x 48	30 x 30
Shoulder Ends	W8-25	6F.16	36 x 36	48 x 48	30 x 30
Lane Ends	W9-1,2	6F.16	36 x 36	48 x 48	30 x 30
Center Lane Closed Ahead	W9-3	6F.23	36 x 36	48 x 48	30 x 30
Grade Crossing Advance Warning	W10-1	6F.16	36 dia.	—	—
Truck	W11-10	6F.36	36 x 36	48 x 48	30 x 30
Double Arrow	W12-1	6F.16	30 x 30	—	—
Low Clearance	W12-2	6F.16	36 x 36	48 x 48	30 x 30
Advisory Speed (plaque)	W13-1P	6F.52	24 x 24	30 x 30	18 x 18
On Ramp (plaque)	W13-4P	6F.25	36 x 36	36 x 36	—
No Passing Zone (pennant)	W14-3	6F.16	48 x 48 x 36	64 x 64 x 48	40 x 40 x 30
XX Feet (plaque)	W16-2P	6F.16	24 x 18	30 x 24	—
Road Work (with distance)	W20-1	6F.18	36 x 36	48 x 48	30 x 30





Table 6F-1. Temporary Traffic Control Zone Sign and Plaque Sizes (Sheet 3 of 3)

Sign or Plaque	Sign Designation	Section	Conventional Road	Freeway or Expressway	Minimum
Detour (with distance)	W20-2	6F.19	36 x 36	48 x 48	30 x 30
Road (Street) Closed (with distance)	W20-3	6F.20	36 x 36	48 x 48	30 x 30
One Lane Road (with distance)	W20-4	6F.21	36 x 36	48 x 48	30 x 30
Lane(s) Closed (with distance)	W20-5,5a	6F.22	36 x 36	48 x 48	30 x 30
Flagger (symbol)	W20-7	6F.31	36 x 36	48 x 48	30 x 30
Flagger	W20-7a	6F.31	36 x 36	48 x 48	30 x 30
Slow (on Stop/Slow Paddle)	W20-8	6E.03	18 x 18	—	—
Workers	W21-1,1a	6F.33	36 x 36	48 x 48	30 x 30
Fresh Oil (Tar)	W21-2	6F.34	36 x 36	48 x 48	30 x 30
Road Machinery Ahead	W21-3	6F.35	36 x 36	48 x 48	30 x 30
Slow Moving Vehicle	W21-4	6G.06	36 x 18	—	—
Shoulder Work	W21-5	6F.37	36 x 36	48 x 48	30 x 30
Shoulder Closed	W21-5a	6F.37	36 x 36	48 x 48	30 x 30
Shoulder Closed (with distance)	W21-5b	6F.37	36 x 36	48 x 48	30 x 30
Survey Crew	W21-6	6F.38	36 x 36	48 x 48	30 x 30
Utility Work Ahead	W21-7	6F.39	36 x 36	48 x 48	30 x 30
Mowing Ahead	W21-8	6G.06	36 x 36	48 x 48	30 x 30
Blasting Zone Ahead	W22-1	6F.41	36 x 36	48 x 48	30 x 30
Turn Off 2-Way Radio and Cell Phone	W22-2	6F.42	42 x 36	42 x 36	—
End Blasting Zone	W22-3	6F.43	42 x 36	42 x 36	36 x 30
Slow Traffic Ahead	W23-1	6F.27	48 x 24	48 x 24	—
New Traffic Pattern Ahead	W23-2	6F.30	36 x 36	48 x 48	30 x 30
Double Reverse Curve (1 lane)	W24-1	6F.49	36 x 36	48 x 48	30 x 30
Double Reverse Curve (2 lanes)	W24-1a	6F.49	36 x 36	48 x 48	30 x 30
Double Reverse Curve (3 lanes)	W24-1b	6F.49	36 x 36	48 x 48	30 x 30
All Lanes	W24-1cP	6F.49	24 x 24	30 x 30	—
Road Work Next XX Miles	G20-1	6F.56	36 x 18	48 x 24	—
End Road Work	G20-2	6F.57	36 x 18	48 x 24	—
Pilot Car Follow Me	G20-4	6F.58	36 x 18	—	—
Work Zone (plaque)	G20-5aP	6F.12	24 x 18	36 x 24	—
Exit Open	E5-2	6F.28	48 x 36	48 x 36	—
Exit Closed	E5-2a	6F.28	48 x 36	48 x 36	—
Exit Only	E5-3	6F.29	48 x 36	48 x 36	—
Detour	M4-8	6F.59	24 x 12	30 x 15	—
End Detour	M4-8a	6F.59	24 x 18	24 x 18	—
End	M4-8b	6F.59	24 x 12	24 x 12	—
Detour	M4-9	6F.59	30 x 24	48 x 36	—
Bike/Pedestrian Detour	M4-9a	6F.59	30 x 24	—	—
Pedestrian Detour	M4-9b	6F.59	30 x 24	—	—
Bike Detour	M4-9c	6F.59	30 x 24	—	—
Detour	M4-10	6F.59	48 x 18	—	—

\* See Table 2B-1 for minimum size required for signs facing traffic on multi-lane conventional roads

- Notes: 1. Larger signs may be used wherever necessary for greater legibility or emphasis  
2. Dimensions are shown in inches and are shown as width x height



# 7 - Schools





# Part 7 Schools



S1-1



W16-9P YG



W16-7PL YG



W16-7PR YG



S4-99P



S4-1P



S4-2P



S4-3P



S4-4P



S4-6P



S3-1



S4-5 15



S4-5 25



S5-1 15

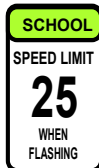

S5-1 25



S5-1a 15



S5-1a 25



S5-1c 15



S5-1c 25



S5-1V



S5-2



R1-6



R1-6b



## CHAPTER 7B. SIGNS

Section 7B.01 Size of School Signs

## Standard:

- 01 Except as provided in Section 2A.11, the sizes of signs and plaques to be used on conventional roadways in school areas shall be as shown in Table 7B-1.
- 02 The sizes in the Conventional Road column shall be used unless engineering judgment determines that a minimum or oversized sign size would be more appropriate.
- 03 The sizes in the Minimum column shall be used only where traffic volumes are low and speeds are 30 mph or lower, as determined by engineering judgment.
- 04 The sizes in the Oversized column shall be used on expressways.

## Guidance:

- 05 The sizes in the Oversized column should be used on roadways that have four or more lanes with posted speed limits of 40 mph or higher.

## Option:

- 06 The sizes in the Oversized column may also be used at other locations that require increased emphasis, improved recognition, or increased legibility.
- 07 Signs and plaques larger than those shown in Table 7B-1 may be used (see Section 2A.11).

Table 7B-1. School Area Sign and Plaque Sizes

Sign	Sign Designation	Section	Conventional Road	Minimum	Oversized
School	S1-1	7B.08	36 x 36	30 x 30	48 x 48
School Bus Stop Ahead	S3-1	7B.13	36 x 36	30 x 30	48 x 48
School Bus Turn Ahead	S3-2	7B.14	36 x 36	30 x 30	48 x 48
Reduced School Speed Limit Ahead	S4-5, S4-5a	7B.16	36 x 36	30 x 30	48 x 48
School Speed Limit XX When Flashing	S5-1	7B.15	24 x 48	—	36 x 72
End School Zone	S5-2	7B.09	24 x 30	—	36 x 48
End School Speed Limit	S5-3	7B.15	24 x 30	—	36 x 48
In-Street Ped Crossing	R1-6, R1-6a, R1-6b, R1-6c	7B.11, 7B.12	12 x 36	—	—
Speed Limit (School Use)	R2-1	7B.15	24 x 30	—	36 x 48
Begin Higher Fines Zone	R2-10	7B.10	24 x 30	—	36 x 48
End Higher Fines Zone	R2-11	7B.10	24 x 30	—	36 x 48

Plaque	Sign Designation	Section	Conventional Road	Minimum	Oversized
X:XX to X:XX AM X:XX to X:XX PM	S4-1P	7B.15	24 x 10	—	36 x 18
When Children Are Present	S4-2P	7B.15	24 x 10	—	36 x 18
School	S4-3P	7B.09, 7B.15	24 x 8	—	36 x 12
When Flashing	S4-4P	7B.15	24 x 10	—	36 x 18
Mon-Fri	S4-6P	7B.15	24 x 10	—	36 x 18
All Year	S4-7P	7B.09	24 x 12	—	30 x 18
Fines Higher	R2-6P	7B.10	24 x 18	—	36 x 24
XX Feet	W16-2P	7B.08	24 x 18	—	30 x 24
XX Ft	W16-2aP	7B.08	24 x 12	—	30 x 18
Turn Arrow	W16-5P	7B.08, 7B.09, 7B.11	24 x 12	—	30 x 18
Advance Turn Arrow	W16-6P	7B.08, 7B.09, 7B.11	24 x 12	—	30 x 18
Diagonal Arrow	W16-7P	7B.12	24 x 12	—	30 x 18
Diagonal Arrow (optional size)	W16-7P	7B.12	21 x 15	—	—
Ahead	W16-9P	7B.11	24 x 12	—	30 x 18

- Note: 1. Larger sizes may be used when appropriate  
 2. Dimensions are shown in inches and are shown as width x height  
 3. Minimum sign sizes for multi-lane conventional roads shall be as shown in the Conventional Road column



## Part 7 - Schools

# Typical School Zone Layouts

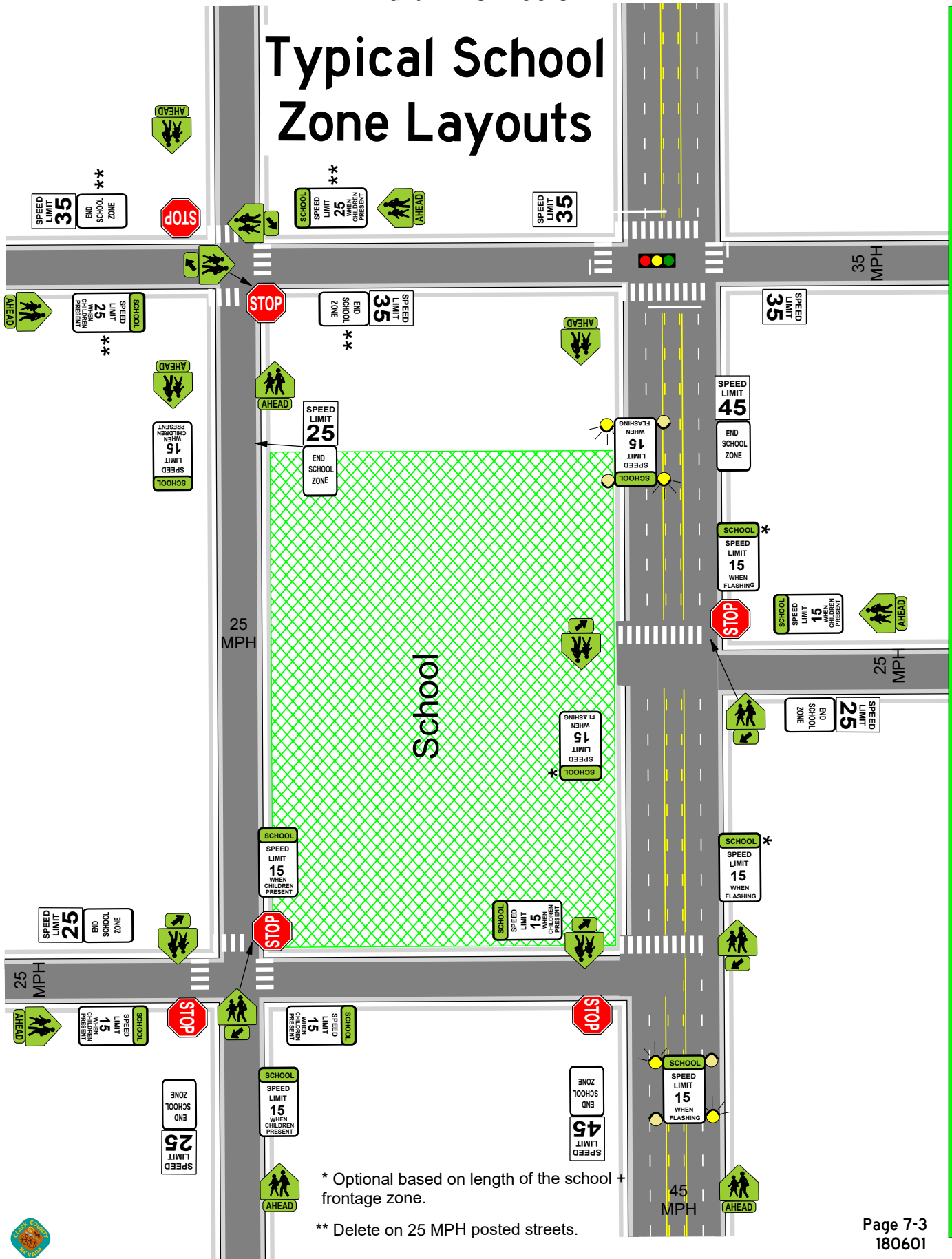

## Part 7 - Schools

# Internal Speed Zone signs with flashers

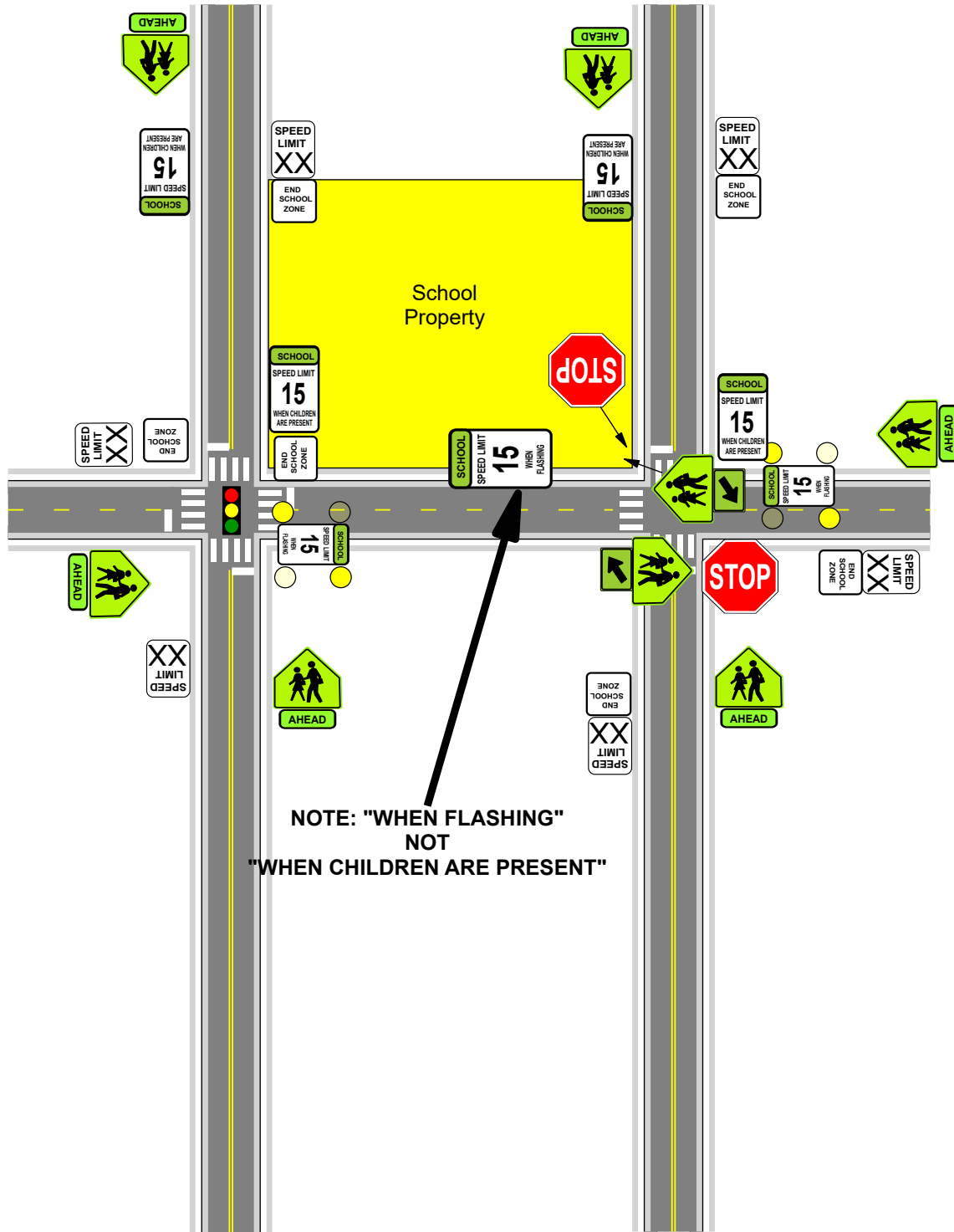

NOTE: "WHEN FLASHING"  
NOT  
"WHEN CHILDREN ARE PRESENT"





Part 7 - Schools

# School Crossings on posted 25 MPH

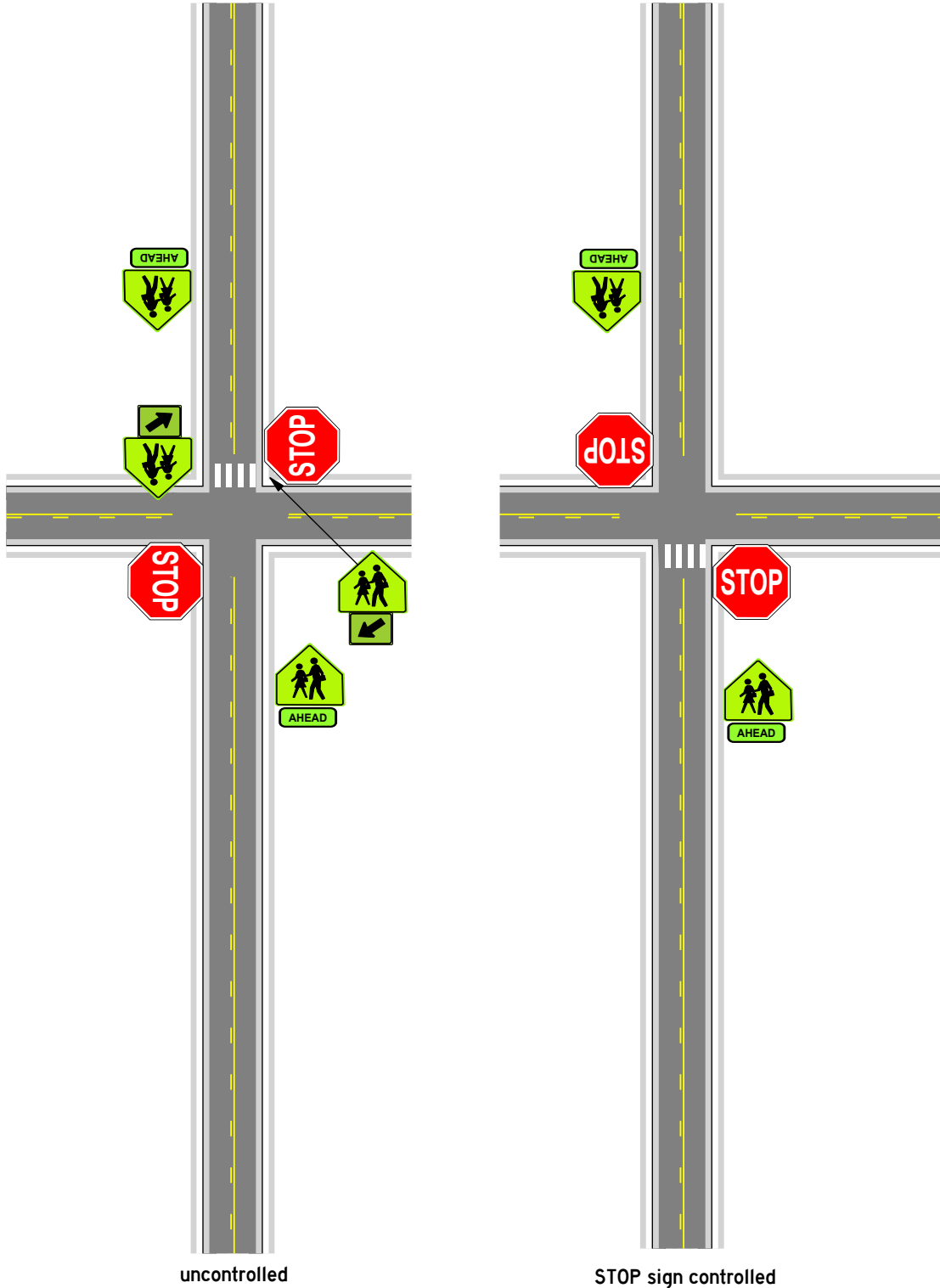

## Part 7 - Schools

# School Crossings on posted over 25 MPH

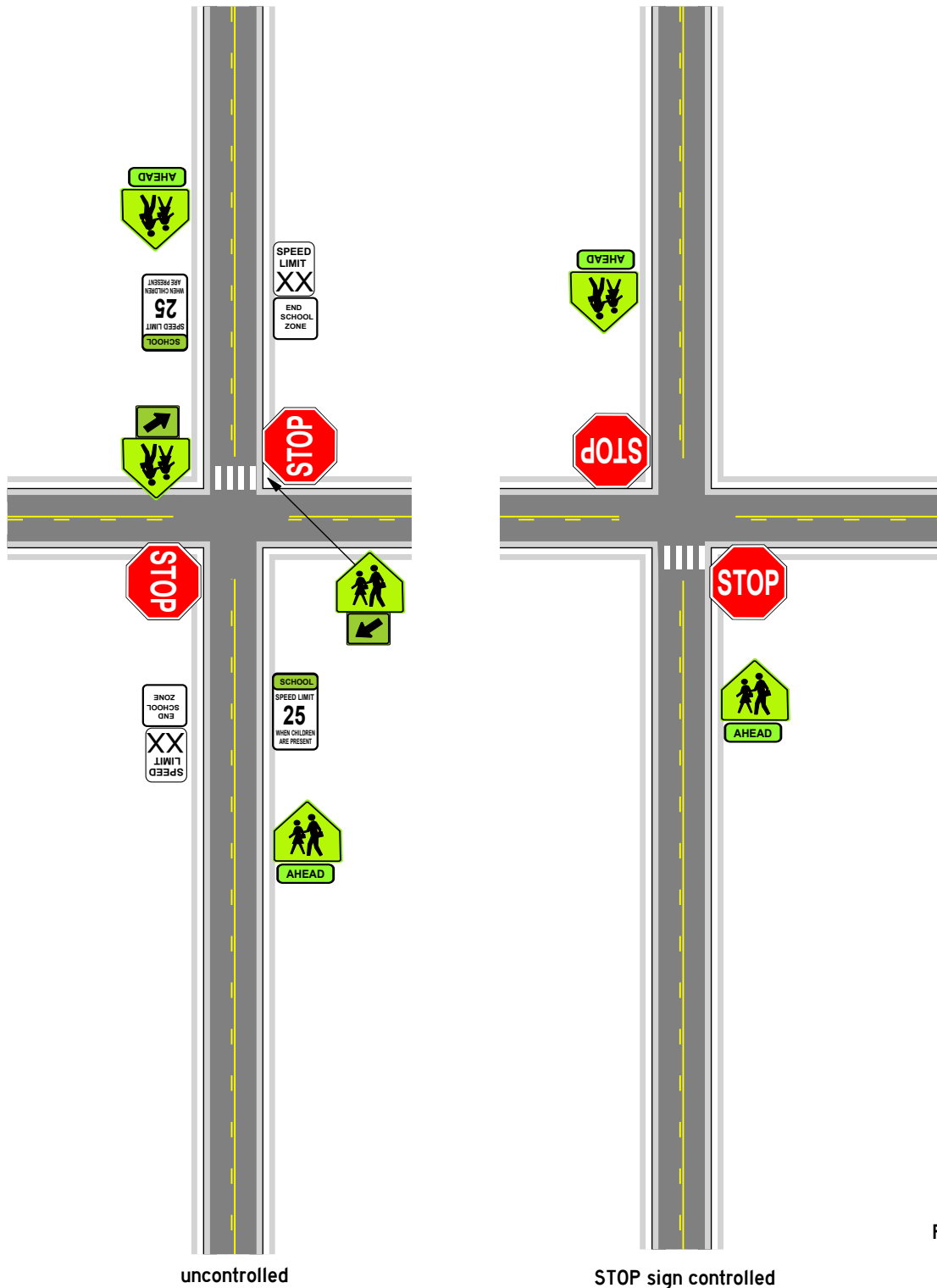



# Part 7 - Schools

## Typical SCHOOL, Reduced Speed, END SCHOOL ZONE layout

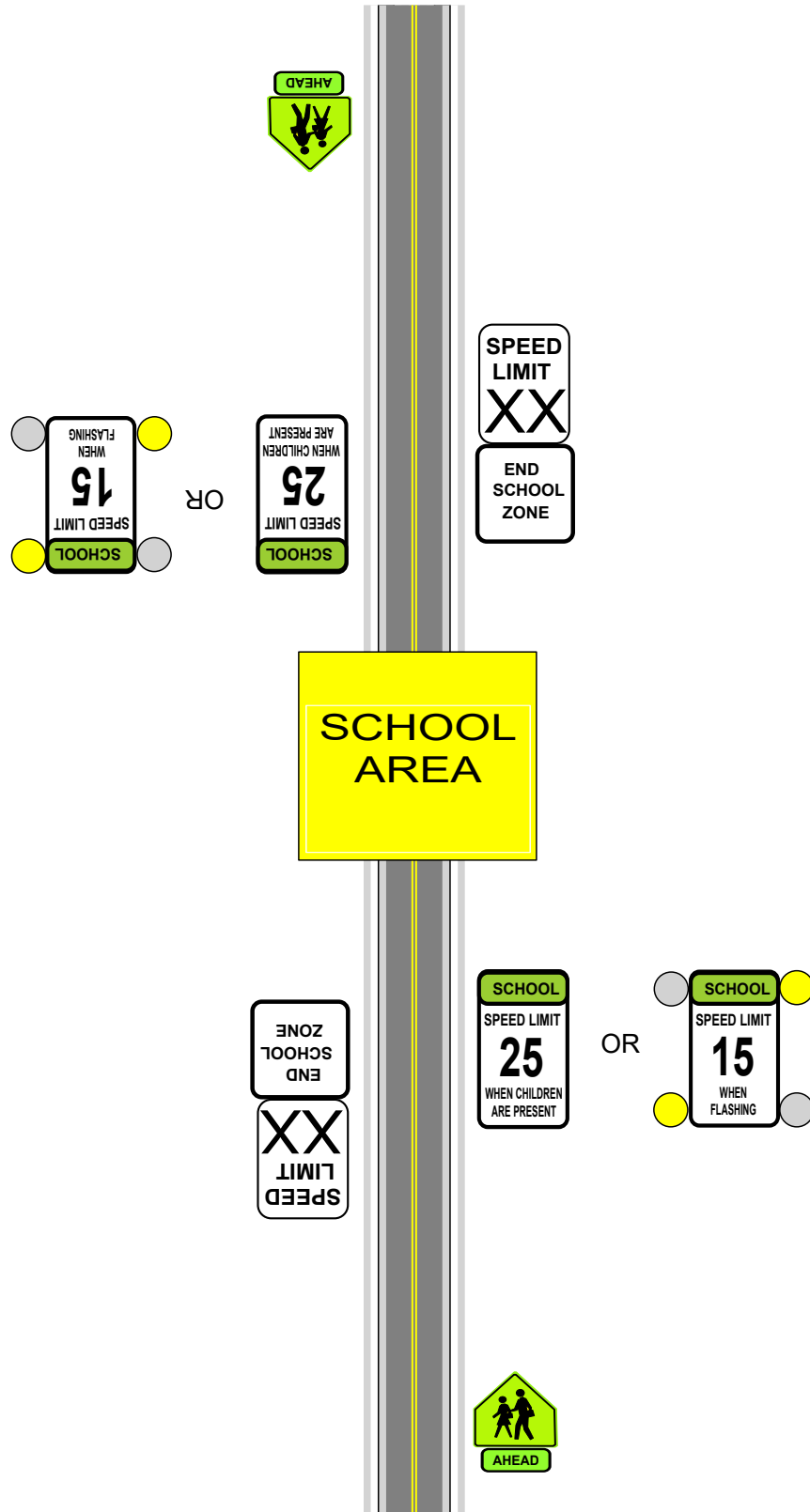

## END SCHOOL ZONE sign order

Incorrect

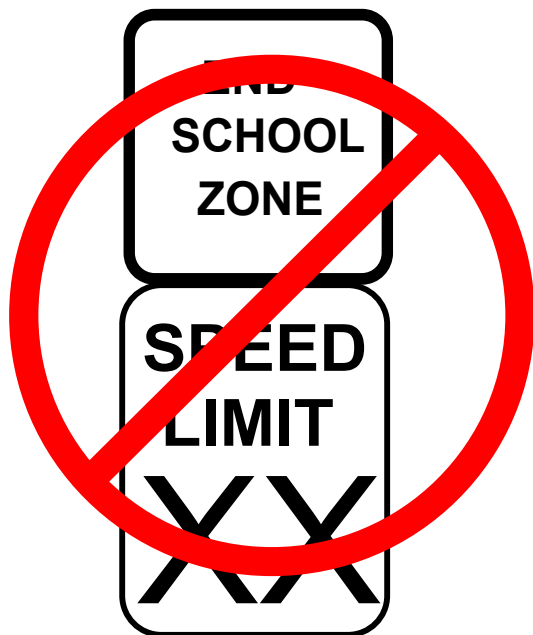

Correct

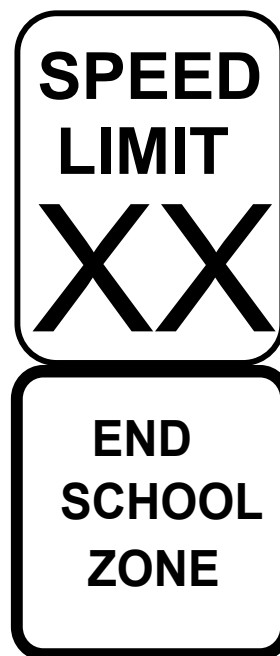

**7B.15 A standard Speed Limit sign showing the speed limit for the section of highway that is downstream from the authorized and posted reduced school speed limit zone may be mounted on the same post above the END SCHOOL SPEED LIMIT (S5-3) sign or the END SCHOOL ZONE (S5-2) sign.**



# 8 - Railroad and Light Rail



Part 8  
Railroad and Light Rail

	R1-1		R15-4a		W10-1		W10-12a
	R1-2		R15-4b		W10-1aP		W10-12b
Activated Blank-Out 	R3-1a		R15-4c		W10-2		W10-13P
	R3-2a		R15-5				W10-14P
	R8-8		R15-5a		W10-3		W10-14aP
	R8-9		R15-5a				W10-15P
	R8-10L		R15-6				I-13
	R8-10R		R15-6a		W10-4L		
	R8-10aL		R15-7		W10-4R		
	R8-10aR		R15-7a		W10-5		
	R10-6L		R15-8		W10-5P		
	R10-6R			Activated Blank-Out 	W10-7		
	R10-6aL				W10-8 (XX)		
	R10-6aR				W10-9		
	R15-1				W10-9P		
	R15-2P (#)				W10-11		
	R15-3				W10-11a (XX)		
					W10-11b (XX)		



**Table 8B-1. Grade Crossing Sign and Plaque Minimum Sizes**

Sign or Plaque	Sign Designation	Section	Conventional Road		Expressway	Minimum	Oversized
			Single Lane	Multi-Lane			
Stop	R1-1	8B.04, 8B.05	30 x 30	36 x 36	36 x 36	—	48 x 48
Yield	R1-2	8B.04, 8B.05	36 x 36 x 36	48 x 48 x 48	48 x 48 x 48	30 x 30 x 30	—
No Right Turn Across Tracks	R3-1a	8B.08	24 x 30	30 x 36	—	—	—
No Left Turn Across Tracks	R3-2a	8B.08	24 x 30	30 x 36	—	—	—
Do Not Stop on Tracks	R8-8	8B.09	24 x 30	24 x 30	36 x 48	—	36 x 48
Tracks Out of Service	R8-9	8B.10	24 x 24	24 x 24	36 x 36	—	36 x 36
Stop Here When Flashing	R8-10	8B.11	24 x 36	24 x 36	—	—	36 x 48
Stop Here When Flashing	R8-10a	8B.11	24 x 30	24 x 30	—	—	36 x 42
Stop Here on Red	R10-6	8B.12	24 x 36	24 x 36	—	—	36 x 48
Stop Here on Red	R10-6a	8B.12	24 x 30	24 x 30	—	—	36 x 42
Grade Crossing (Crossbuck)	R15-1	8B.03	48 x 9	48 x 9	—	—	—
Number of Tracks (plaque)	R15-2P	8B.03	27 x 18	27 x 18	—	—	—
Exempt (plaque)	R15-3P	8B.07	24 x 12	24 x 12	—	—	—
Light Rail Only Right Lane	R15-4a	8B.13	24 x 30	24 x 30	—	—	—
Light Rail Only Left Lane	R15-4b	8B.13	24 x 30	24 x 30	—	—	—
Light Rail Only Center Lane	R15-4c	8B.13	24 x 30	24 x 30	—	—	—
Light Rail Do Not Pass	R15-5	8B.14	24 x 30	24 x 30	—	—	—
Do Not Pass Stopped Train	R15-5a	8B.14	24 x 30	24 x 30	—	—	—
No Motor Vehicles On Tracks Symbol	R15-6	8B.15	24 x 24	24 x 24	—	—	—
Do Not Drive On Tracks	R15-6a	8B.15	24 x 30	24 x 30	—	—	—
Light Rail Divided Highway Symbol	R15-7	8B.16	24 x 24	24 x 24	—	—	—
Light Rail Divided Highway Symbol (T-Intersection)	R15-7a	8B.16	24 x 24	24 x 24	—	—	—
Look	R15-8	8B.17	36 x 18	36 x 18	—	—	—
Grade Crossing Advance Warning	W10-1	8B.06	36 Dia.	36 Dia.	48 Dia.	—	48 Dia.
Exempt (plaque)	W10-1aP	8B.07	24 x 12	24 x 12	—	—	—
Grade Crossing and Intersection Advance Warning	W10-2,3,4	8B.06	36 x 36	36 x 36	48 x 48	—	48 x 48
Low Ground Clearance	W10-5	8B.23	36 x 36	36 x 36	48 x 48	—	48 x 48
Low Ground Clearance (plaque)	W10-5P	8B.23	30 x 24	30 x 24	—	—	—
Light Rail Activated Blank-Out Symbol	W10-7	8B.19	24 x 24	24 x 24	—	—	—
Trains May Exceed 80 MPH	W10-8	8B.20	36 x 36	36 x 36	48 x 48	—	48 x 48
No Train Horn	W10-9	8B.21	36 x 36	36 x 36	48 x 48	—	48 x 48
No Train Horn (plaque)	W10-9P	8B.21	30 x 24	30 x 24	—	—	—
Storage Space Symbol	W10-11	8B.24	36 x 36	36 x 36	48 x 48	—	48 x 48
Storage Space XX Feet Between Tracks & Highway	W10-11a	8B.24	30 x 36	30 x 36	—	—	—
Storage Space XX Feet Between Highway & Tracks Behind You	W10-11b	8B.24	30 x 36	30 x 36	—	—	—
Skewed Crossing	W10-12	8B.25	36 x 36	36 x 36	48 x 48	—	48 x 48
No Gates or Lights (plaque)	W10-13P	8B.22	30 x 24	30 x 24	—	—	—
Next Crossing (plaque)	W10-14P	8B.23	30 x 24	30 x 24	—	—	—
Use Next Crossing (plaque)	W10-14aP	8B.23	30 x 24	30 x 24	—	—	—
Rough Crossing (plaque)	W10-15P	8B.23	30 x 24	30 x 24	—	—	36 x 30







































































- Notes: 1. Larger signs may be used when appropriate  
2. Dimensions in inches are shown as width x height  
3. Table 9B-1 shows the minimum sizes that may be used for grade crossing signs and plaques that face shared-use paths and pedestrian facilities



# 9 - Bike Facilities

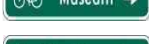

Part 9  
Bike Facilities

	R1-1		R9-7		W5-2		D4-3L (R if arrow to right)
	R1-2		R9-13		W5-4a		D11-1
	R3-17		R9-14		W7-5		D11-1a
	R3-17aP*		<b>R9-99</b>		W8-10		D11-1b
	R3-17bP*		R10-4L		W8-10P**		D11-1c
	R4-1		R10-4R		W10-12a		D11-2
	R4-2		R10-22		W10-12b		D11-3
	R4-3		R10-24		W11-1		D11-4
	R4-4		R10-25		W11-2L		D1-1bL (R if arrow to right)
	R4-7		R10-26L		W11-2R		D1-1cR (L if arrow to left)
	R4-16		R10-26R		W11-15		D1-2b
	R5-1b		R5-3		W11-15P		D1-2c
	R9-3cP		R5-6		W16-1		D1-2c
	R5-3		R7-9		W16-1P***		D1-3b
	R5-6		R7-9a				D1-3b
	R7-9		R9-3				D1-3b
	R7-9a		R9-5				D1-3b
	R9-3		R9-6				D1-3c
	R9-5						D1-3c
	R9-6						D1-3c

\* to be mounted below R3-17  
 \*\* to be mounted below W8-10  
 \*\*\* to be mounted below W16-1





Part 9  
Bike Facilities

 M2-1 G

 M3-1 G

 M3-2 G

 M3-3 G

 M3-4 G

 M4-1 G

 M4-1a G

 M4-2 G

 M4-5 G

 M4-6 G

 M4-7 G

 M4-7a G

 M4-14 G

 M5-1L G

 M5-1R G

 M5-2L G

 M5-2R G

 M5-3 G

 M6-1 G

 M6-2L G

 M6-3 G

 M6-4 G

 M6-5L G

 M6-5R G

 M6-6L G

 M6-6R G

 M6-7L G

 M6-7R G



**Table 9B-1. Bicycle Facility Sign and Plaque Minimum Sizes (Sheet 1 of 2)**

Sign or Plaque	Sign Designation	Section	Shared-Use Path	Roadway
Stop	R1-1	2B.05, 9B.03	18 x 18	30 x 30
Yield	R1-2	2B.08, 9B.03	18 x 18 x 18	30 x 30 x 30
Bike Lane	R3-17	9B.04	—	24 x 18
Bike Lane (plaques)	R3-17aP, R3-17bP	9B.04	—	24 x 8
Movement Restriction	R4-1,2,3,7,16	2B.28,29,30,32; 9B.14	12 x 18	18 x 24
Begin Right Turn Lane Yield to Bikes	R4-4	9B.05	—	36 x 30
Bicycles May Use Full Lane	R4-11	9B.06	—	30 x 30
Bicycle Wrong Way	R5-1b	9B.07	12 x 18	12 x 18
No Motor Vehicles	R5-3	9B.08	24 x 24	24 x 24
No Bicycles	R5-6	9B.09	18 x 18	24 x 24
No Parking Bike Lane	R7-9,9a	9B.10	—	12 x 18
No Pedestrians	R9-3	9B.09	18 x 18	18 x 18
Ride With Traffic (plaque)	R9-3cP	9B.07	12 x 12	12 x 12
Bicycle Regulatory	R9-5,6	9B.11	12 x 18	12 x 18
Shared-Use Path Restriction	R9-7	9B.12	12 x 18	—
No Skaters	R9-13	9B.09	18 x 18	18 x 18
No Equestrians	R9-14	9B.09	18 x 18	18 x 18
Push Button for Green Light	R10-4	9B.11	9 x 12	9 x 12
To Request Green Wait on Symbol	R10-22	9B.13	12 x 18	12 x 18
Bike Push Button for Green Light	R10-24	9B.11	9 x 15	9 x 15
Push Button to Turn On Warning Lights	R10-25	9B.11	9 x 12	9 x 12
Bike Push Button for Green Light (arrow)	R10-26	9B.11	9 x 15	9 x 15
Grade Crossing (Crossbuck)	R15-1	8B.03, 9B.14	24 x 4.5	48 x 9
Number of Tracks (plaque)	R15-2P	8B.03, 9B.14	13.5 x 9	27 x 18
Look	R15-8	8B.17, 9B.14	18 x 9	36 x 18
Turn and Curve Warning	W1-1,2,3,4,5	2C.04, 9B.15	18 x 18	24 x 24
Arrow Warning	W1-6,7	2C.12, 2C.47, 9B.15	24 x 12	36 x 18
Intersection Warning	W2-1,2,3,4,5	2C.46, 9B.16	18 x 18	24 x 24
Stop, Yield, Signal Ahead	W3-1,2,3	2C.36, 9B.19	18 x 18	30 x 30
Narrow Bridge	W5-2	2C.20, 9B.19	18 x 18	30 x 30
Path Narrows	W5-4a	9B.19	18 x 18	—
Hill	W7-5	9B.19	18 x 18	30 x 30
Bump or Dip	W8-1,2	2C.28, 9B.17	18 x 18	24 x 24
Pavement Ends	W8-3	2C.30, 9B.17	18 x 18	30 x 30
Bicycle Surface Condition	W8-10	9B.17	18 x 18	30 x 30
Slippery When Wet (plaque)	W8-10P	9B.17	12 x 9	12 x 9
Grade Crossing Advance Warning	W10-1	8B.06, 9B.19	24 Dia.	36 Dia.
No Train Horn (plaque)	W10-9P	8B.21, 9B.19	18 x 12	30 x 24
Skewed Crossing	W10-12	8B.25, 9B.19	18 x 18	36 x 36
Bicycle Warning	W11-1	9B.18	18 x 18	24 x 24
Pedestrian Crossing	W11-2	2C.50, 9B.19	18 x 18	24 x 24
Combination Bike and Ped Crossing	W11-15	9B.18	18 x 18	30 x 30
Trail Crossing (plaque)	W11-15P	9B.18	18 x 12	24 x 18
Low Clearance	W12-2	2C.27, 9B.19	18 x 18	30 x 30
Playground	W15-1	2C.51, 9B.19	18 x 18	24 x 24
Share the Road (plaque)	W16-1P	2C.60, 9B.19	—	18 x 24



**Table 9B-1. Bicycle Facility Sign and Plaque Minimum Sizes (Sheet 2 of 2)**

Sign or Plaque	Sign Designation	Section	Shared-Use Path	Roadway
XX Feet (plaque)	W16-2P	2C.55, 9B.18	18 x 12	24 x 18
XX Ft (plaque)	W16-2aP	2C.55, 9B.18	18 x 9	24 x 12
Diagonal Arrow (plaque)	W16-7P	9B.18	—	24 x 12
Ahead (plaque)	W16-9P	9B.18	—	24 x 12
Destination (1 line)	D1-1, D1-1a	2D.37, 9B.20	varies x 6	varies x 18
Bicycle Destination (1 line)	D1-1b, D1-1c	9B.20	varies x 6	varies x 6
Destination (2 lines)	D1-2, D1-2a	2D.37, 9B.20	varies x 12	varies x 30
Bicycle Destination (2 lines)	D1-2b, D1-2c	9B.20	varies x 12	varies x 12
Destination (3 lines)	D1-3, D1-3a	2D.37, 9B.20	varies x 18	varies x 42
Bicycle Destination (3 lines)	D1-3b, D1-3c	9B.20	varies x 18	varies x 18
Street Name	D3-1	2D.43, 9B.20	varies x 6	varies x 8
Bicycle Parking Area	D4-3	9B.23	12 x 18	12 x 18
Reference Location (1-digit)	D10-1	2H.02, 9B.24	6 x 12	10 x 18
Intermediate Reference Location (1-digit)	D10-1a	2H.02, 9B.24	6 x 18	10 x 27
Reference Location (2-digit)	D10-2	2H.02, 9B.24	6 x 18	10 x 27
Intermediate Reference Location (2-digit)	D10-2a	2H.02, 9B.24	6 x 24	10 x 36
Reference Location (3-digit)	D10-3	2H.02, 9B.24	6 x 24	10 x 36
Intermediate Reference Location (3-digit)	D10-3a	2H.02, 9B.24	6 x 30	10 x 48
Bike Route	D11-1, D11-1c	9B.20	24 x 18	24 x 18
Bicycles Permitted	D11-1a	9B.25	18 x 18	—
Bike Route (plaque)	D11-1bP	9B.25	18 x 6	—
Pedestrians Permitted	D11-2	9B.25	18 x 18	—
Skaters Permitted	D11-3	9B.25	18 x 18	—
Equestrians Permitted	D11-4	9B.25	18 x 18	—
Bicycle Route	M1-8, M1-8a	9B.21	12 x 18	18 x 24
U.S. Bicycle Route	M1-9	9B.21	12 x 18	18 x 24
Bicycle Route Auxiliary Signs	M2-1; M3-1,2,3,4; M4-1,1a,2,3,5,6,7,7a,8,14	9B.22	12 x 6	12 x 6
Bicycle Route Arrow Signs	M5-1,2; M6-1,2,3,4,5,6,7	9B.22	12 x 9	12 x 9
Type 3 Object Markers	OM3-L,C,R	2C.63, 9B.26	6 x 18	12 x 36

- Notes: 1. Larger signs may be used when appropriate  
2. Dimensions are shown in inches and are shown as width x height

*Guidance:*

- 04 *Except for size, the design of signs and plaques for bicycle facilities should be identical to that provided in this Manual for signs and plaques for streets and highways.*

*Support:*

- 05 Uniformity in design of bicycle signs and plaques includes shape, color, symbols, arrows, wording, lettering, and illumination or retroreflectORIZATION.

**Section 9B.03 STOP and YIELD Signs (R1-1, R1-2)**

**Standard:**

- 01 **STOP (R1-1) signs** (see Figure 9B-2) shall be installed on shared-use paths at points where bicyclists are required to stop.
- 02 **YIELD (R1-2) signs** (see Figure 9B-2) shall be installed on shared-use paths at points where bicyclists have an adequate view of conflicting traffic as they approach the sign, and where bicyclists are required to yield the right-of-way to that conflicting traffic.



# Clark County Signs

# Trails



# Clark County Trail Signs

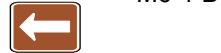

# Clark County Signs

## Non-Roadway



# Clark County Non-Roadway Signs



CCC1-1

CCC1-2

CCF1-1

CCF1-2

CCHD1-1

CCHD1-2

CCL1-1

CCL1-2



CCL3-1

CCL3-2



CCL4-1

CCL9-1

CCL9-2

CCL10-1

CCL11-1

CCL12-1

CCL13-1



CCNW1-1



CCR10-1



RTC1-1































# **Clark County Signs**







## **Replace when Found**



# REPLACE WHEN FOUND

Replace with

	NMI-5 B	➔		I-5
	R2-1 15	➔		R2-1 25
	R2-1 20	➔		R2-1 25
	NMS1-1	➔		S1-1 W16-9 YG
	NMS2-1	➔		S1-1 W16-7PR YG
	NMW4-2R	➔		W4-2R
	NMW4-2L	➔		W4-2L
	NMW4-4xP	➔		W4-4P
	NMW4-4zP	➔		W4-4P
	NMW8-3a	➔		W8-3
	NMW11-2	➔		W11-2 W16-9P YG
	NMW11-2a	➔		W11-2 W16-7PR YG
	NMW8-93	➔		W14-2

	NMW11-7a	➔		W11-7 W16-7PR
	NMW11-7	➔		W11-7 W16-9P
	NMD9-10	➔		D9-10

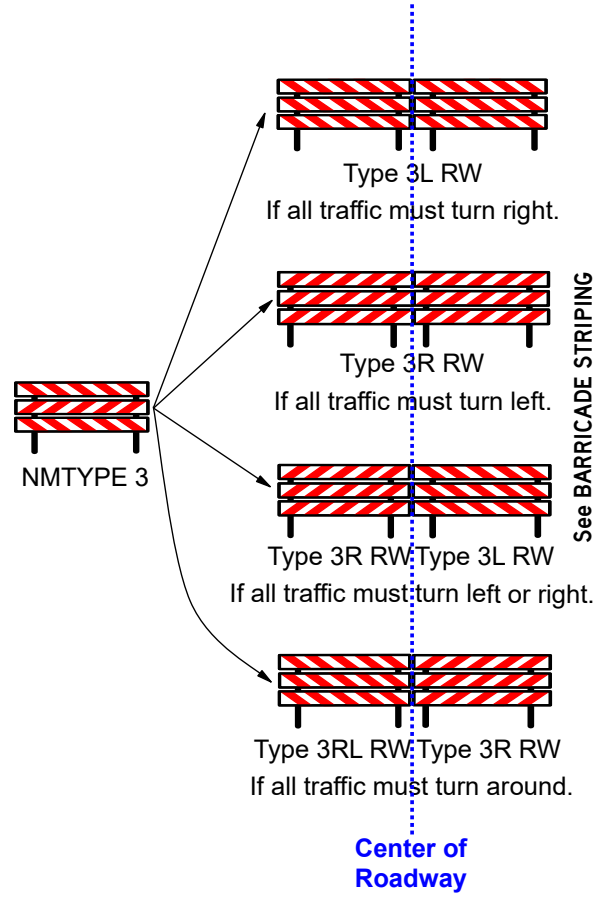

# **Clark County Signs**

## **Replace Warning**



# Incorrect Turn Warning Signs

	NMW1-2aL 15			W1-1aL 15		NMW1-2aR 15			W1-1aR 15
	NMW1-2aL 20			W1-1aL 20		NMW1-2aR 20			W1-1aR 20
	NMW1-2aL 25			W1-1aL 25		NMW1-2aR 25			W1-1aR 25
	NMW1-2aL 30			W1-1aL 30		NMW1-2aR 30			W1-1aR 30
	NMW1-4aL 15			W1-3L		NMW1-4aR 15			W1-3R
				W13-1P 15					W13-1P 15
	NMW1-4aL 20			W1-3L		NMW1-4aR 20			W1-3R
				W13-1P 20					W13-1P 20
	NMW1-4aL 25			W1-3L		NMW1-4aR 25			W1-3R
				W13-1P 25					W13-1P 25
	NMW1-4aL 30			W1-3L		NMW1-4aR 30			W1-3R
				W13-1P 15					W13-1P 15



# **Clark County Signs**

## **Remove and Not To Be Used**



## Remove and Not To Be Used



**NM1-1**



**XR7-200M L**

Remove - Not supported by code or law.



**XR7-97**

Remove - Not supported by code or law.



**NM1-2**



**XR7-200M R**

Remove - Not supported by code or law.



**R7-4L**

Replace with R7-1a



**NM1-3**



**R7-4**



**NM1-4**



**XR7-201aP**



**XR7-201r**



**XR7-201b**

Remove - Not supported by code or law.



**R7-4R**



**NM2-1**



**XR7-1v**

Remove - Not supported by code or law.



**NM2-2**



**XR7-6**

Remove - Not supported by code or law.



**R14-4**



**XR7-5**

Remove - Not supported by code or law.



**R14-5**



**XGA-S1**



**XR7-2**

Remove - Not supported by code or law.



**XI-8P**



**XR7-107V**

Remove - Not supported by code or law.



**XR7-108**

or with L or R arrow

Remove - Not supported by code or law.



# **Clark County Signs**

## **Upgrade when Replaced**





# Upgrade when Replaced

	<b>NMR3-8z</b>	➤		RNV2-10		➤		R7-9a
	<b>NMR3-8y</b>	➤		RNV2-10		➤		R8-3
	RNV1-1	➤		RNV2-10		➤		R8-3
	RNV1-2	➤		RNV2-11		➤		R8-3
	XR7-1	➤		R7-1a				
	XR7-1L	➤		R7-1aL				
	XR7-1R	➤		R7-1aR				
	R7-4	➤		R7-1a				
	R7-4L	➤		R7-1aL				
	R7-4R	➤		R7-1aR				
	<b>XR7-7</b>	➤		R7-107a				
	<b>XR7-7L</b>	➤		R7-107aL				
	<b>XR7-7R</b>	➤		R7-107aR				





















# **Clark County Signs**

## **Las Vegas Strip ONLY**



# Clark County - Las Vegas Strip

	<b>CCL2-1</b>		<b>CCL2-8Pk L</b>		<b>CCL2-8Pk R</b>
	<b>CCL2-1a</b>		<b>CCL2-8Pn L</b>		<b>CCL2-8Pn R</b>
	<b>CCL2-2</b>		<b>CCL2-8Pq L</b>		<b>CCL2-8Pq R</b>
	<b>CCL2-3</b>		<b>R7-99L</b>		
	<b>CCL2-4</b>		<b>R7-99R</b>		
	<b>CCL2-5</b>		<b>R7-99T</b>		
	<b>CCL2-6</b>				
	<b>CCL2-7</b>				
	<b>CCM1-1</b>				
	<b>CCN1-1</b>				



# Clark County - Las Vegas Strip

WEEKENDS  
2:00 PM - 12:30 AM  
FRIDAY THRU SUNDAY  
HOLIDAY WEEKENDS  
12:00 PM - 12:30 AM  
FRIDAY THRU MONDAY  
START

**CCL2-8Pa B**

WEEKENDS  
2:00 PM - 12:30 AM  
FRIDAY THRU SUNDAY  
HOLIDAY WEEKENDS  
12:00 PM - 12:30 AM  
FRIDAY THRU MONDAY  
↔

**CCL2-8Pa C**

WEEKENDS  
2:00 PM - 12:30 AM  
FRIDAY THRU SUNDAY  
HOLIDAY WEEKENDS  
12:00 PM - 12:30 AM  
FRIDAY THRU MONDAY  
END

**CCL2-8Pa E**

DAILY  
10:30 AM - 2:30 AM  
START

**CCL2-8Pb B**

DAILY  
10:30 AM - 2:30 AM  
↔

**CCL2-8Pb C**

DAILY  
10:30 AM - 2:30 AM  
END

**CCL2-8Pb E**

DAILY  
10:30 AM - 3:00 AM  
START

**CCL2-8Pc B**

DAILY  
10:30 AM - 3:00 AM  
↔

**CCL2-8Pc C**

DAILY  
10:30 AM - 3:00 AM  
END

**CCL2-8Pc E**

DAILY  
11:30 AM - 1:00 PM  
START

**CCL2-8Pd B**

DAILY  
11:30 AM - 1:00 PM  
↔

**CCL2-8Pd C**

DAILY  
11:30 AM - 1:00 PM  
END

**CCL2-8Pd E**

DAILY  
5:30 PM - 2:00 PM  
START

**CCL2-8Pe B**

DAILY  
5:30 PM - 2:00 PM  
↔

**CCL2-8Pe C**

DAILY  
5:30 PM - 2:00 PM  
END

**CCL2-8Pe E**

DAILY  
8:00 PM - 12:30 AM  
HOLIDAY WEEKENDS  
12:00 PM - 12:30 AM  
FRIDAY THRU MONDAY  
START

**CCL2-8Pf B**

DAILY  
8:00 PM - 12:30 AM  
HOLIDAY WEEKENDS  
12:00 PM - 12:30 AM  
FRIDAY THRU MONDAY  
↔

**CCL2-8Pf C**

DAILY  
8:00 PM - 12:30 AM  
HOLIDAY WEEKENDS  
12:00 PM - 12:30 AM  
FRIDAY THRU MONDAY  
END

**CCL2-8Pf E**

DAILY  
8:00 PM - 1:00 AM  
HOLIDAY WEEKENDS  
1:00 PM - 1:00 AM  
FRIDAY THRU SUNDAY  
START

**CCL2-8Pg B**

DAILY  
8:00 PM - 1:00 AM  
HOLIDAY WEEKENDS  
1:00 PM - 1:00 AM  
FRIDAY THRU SUNDAY  
↔

**CCL2-8Pg C**

DAILY  
8:00 PM - 1:00 AM  
HOLIDAY WEEKENDS  
1:00 PM - 1:00 AM  
FRIDAY THRU SUNDAY  
END

**CCL2-8Pg E**

HOLIDAY WEEKENDS  
2:00 PM - 12:30 AM  
FRIDAY THRU SUNDAY  
START

**CCL2-8Ph B**

HOLIDAY WEEKENDS  
2:00 PM - 12:30 AM  
FRIDAY THRU SUNDAY  
↔

**CCL2-8Ph C**

HOLIDAY WEEKENDS  
2:00 PM - 12:30 AM  
FRIDAY THRU SUNDAY  
END

**CCL2-8Ph E**

WEEKENDS  
2:00 PM - 12:30 AM  
FRIDAY THRU SUNDAY  
START

**CCL2-8Pj B**

WEEKENDS  
2:00 PM - 12:30 AM  
FRIDAY THRU SUNDAY  
↔

**CCL2-8Pj C**

WEEKENDS  
2:00 PM - 12:30 AM  
FRIDAY THRU SUNDAY  
END

**CCL2-8Pj E**

HOLIDAY WEEKENDS  
3:00 PM - 11:30 PM  
FRIDAY THRU SUNDAY  
START

**CCL2-8Pk B**

HOLIDAY WEEKENDS  
3:00 PM - 11:30 PM  
FRIDAY THRU SUNDAY  
↔

**CCL2-8Pk C**

HOLIDAY WEEKENDS  
3:00 PM - 11:30 PM  
FRIDAY THRU SUNDAY  
END

**CCL2-8Pk E**

HOLIDAY WEEKENDS  
3:00 PM - 12:00 AM  
FRIDAY THRU SUNDAY  
START

**CCL2-8Pm B**

HOLIDAY WEEKENDS  
3:00 PM - 12:00 AM  
FRIDAY THRU SUNDAY  
↔

**CCL2-8Pm C**

HOLIDAY WEEKENDS  
3:00 PM - 12:00 AM  
FRIDAY THRU SUNDAY  
END

**CCL2-8Pm E**

HOLIDAY WEEKENDS  
7:00 PM - 12:30 AM  
FRIDAY THRU SUNDAY  
START

**CCL2-8Pn B**

HOLIDAY WEEKENDS  
7:00 PM - 12:30 AM  
FRIDAY THRU SUNDAY  
↔

**CCL2-8Pn C**

HOLIDAY WEEKENDS  
7:00 PM - 12:30 AM  
FRIDAY THRU SUNDAY  
END

**CCL2-8Pn E**

HOLIDAY WEEKENDS  
7:00 PM - 12:30 AM  
FRIDAY THRU MONDAY  
START

**CCL2-8Pp B**

HOLIDAY WEEKENDS  
7:00 PM - 12:30 AM  
FRIDAY THRU MONDAY  
↔

**CCL2-8Pp C**

HOLIDAY WEEKENDS  
7:00 PM - 12:30 AM  
FRIDAY THRU MONDAY  
END

**CCL2-8Pp E**

HOLIDAY WEEKENDS  
1:00 PM - 12:00 AM  
SATURDAY THRU SUNDAY  
START

**CCL2-8Pq B**

HOLIDAY WEEKENDS  
1:00 PM - 12:00 AM  
SATURDAY THRU SUNDAY  
↔

**CCL2-8Pq C**

HOLIDAY WEEKENDS  
1:00 PM - 12:00 AM  
SATURDAY THRU SUNDAY  
END

**CCL2-8Pq E**



# Sign Post Requirements



# BLANK STANDARDS

(ENGLISH)

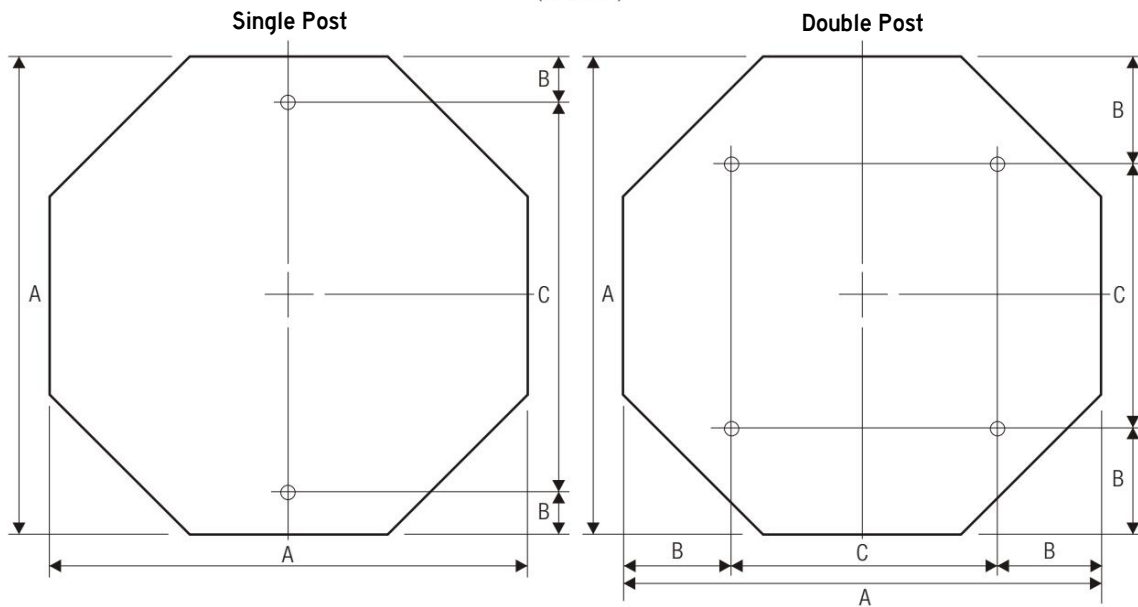

## OCTAGON

A	B	C
24	3	18
30	3	24
36	3	30

A	B	C
48	9	30

Or larger

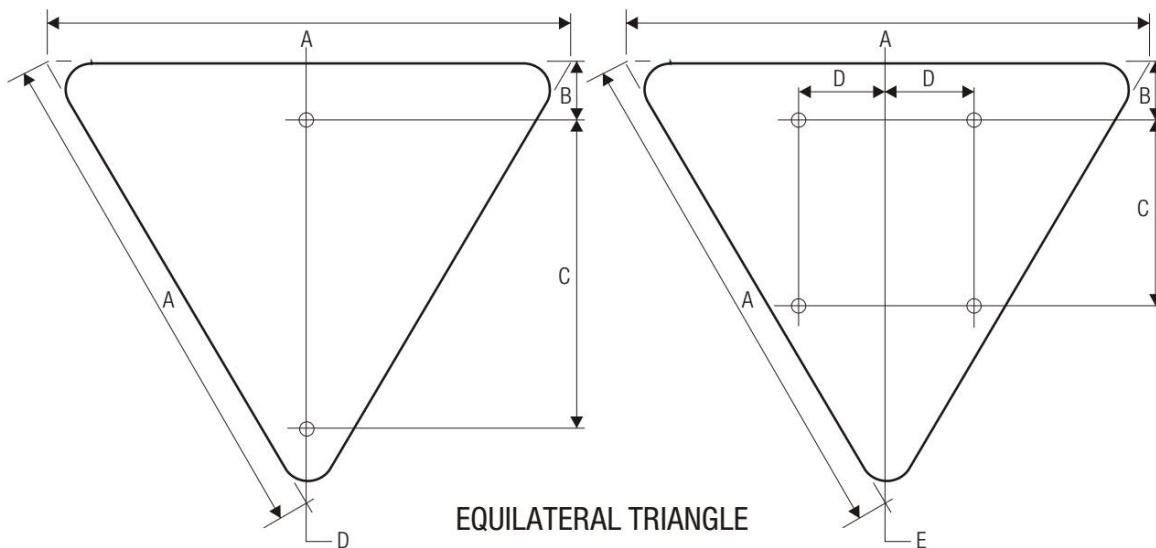

## EQUILATERAL TRIANGLE

A	B	C	D
30	3	18	1.5
36	3	21	2

A	B	C	D	E
48	3	12	12	3
60	3	18	15	4

Or larger



## VERTICAL RECTANGLE

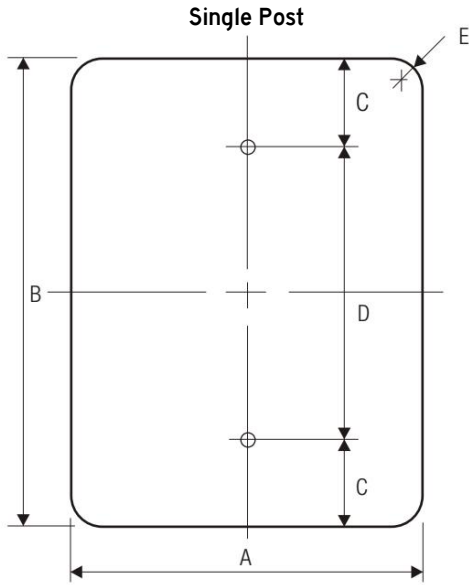

A	B	C	D	E
12	18	1.5	15	1.5
18	24	3	18	1.5
24	30	3	24	1.5
30	36	3	30	1.875

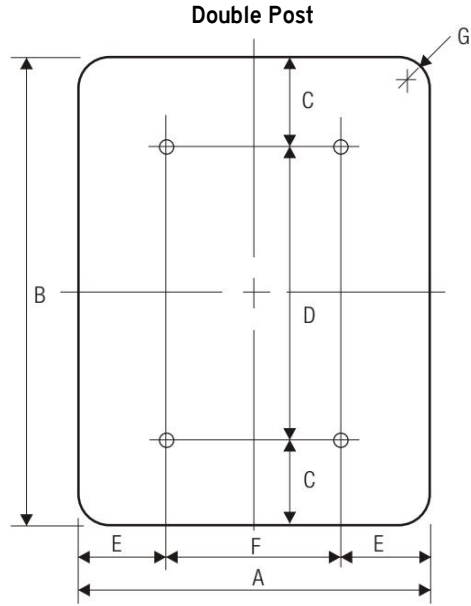

A	B	C	D	E	F	G
36	48	6	36	6	24	2.25
48	60	6	48	9	30	3

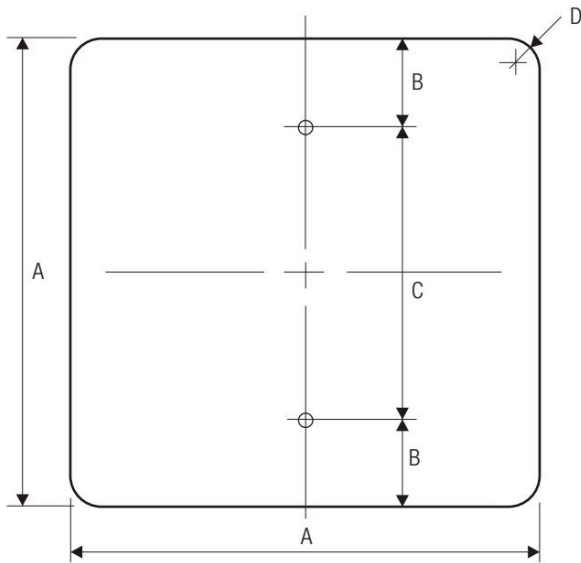

A	B	C	D
18	3	12	1.5
24	3	18	1.5
30	3	24	1.875

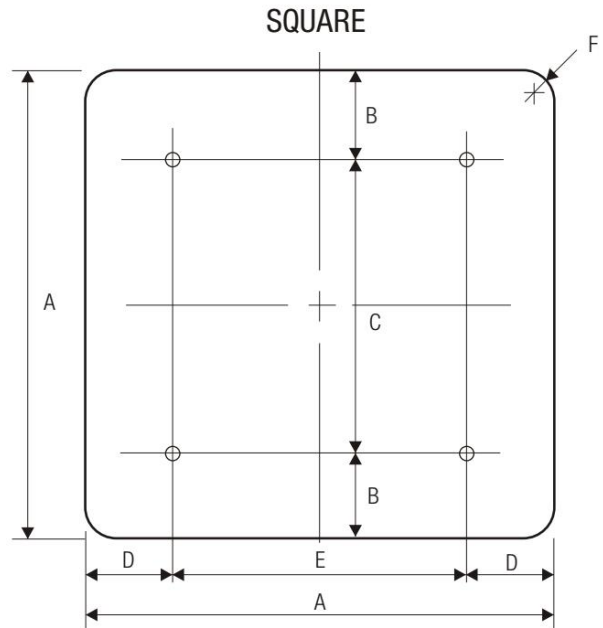

A	B	C	D	E	F
36	6	24	6	24	2.25
48	6	36	9	30	3





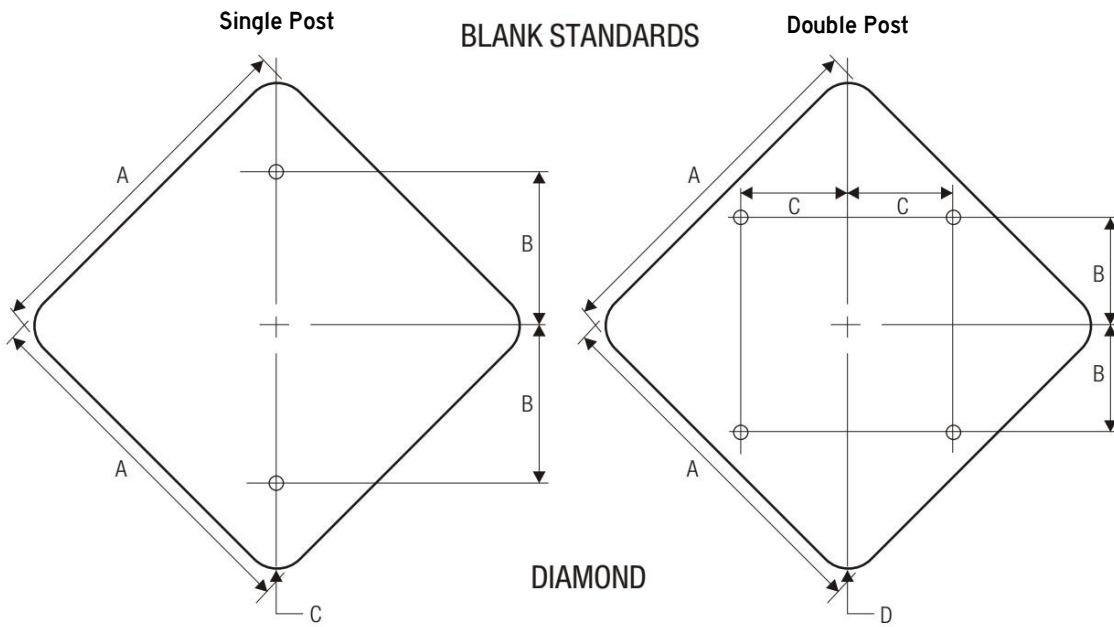

A	B	C
24	12	1.5
30	15	1.875
36	18	2.25

A	B	C	D
48	15	15	3
60	18	18	3.75

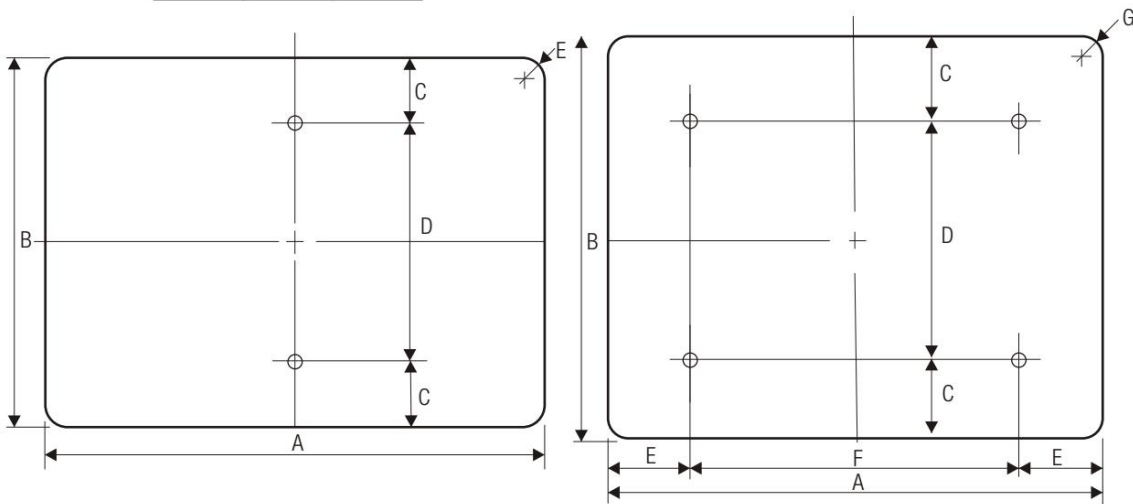

**HORIZONTAL RECTANGLE**

A	B	C	D	E
21	15	1.5	12	1.5
24	12	1.5	9	1.5
24	18	3	12	1.5
30	15	1.5	12	1.5
30	24	3	18	1.5
36	12	1.5	9	1.5

A	B	C	D	E	F	G
36	24	3	18	6	24	1.5
48	24	3	18	9	30	1.875
48	36	6	24	9	30	2.25
60	24	3	18	12	36	1.5
60	36	6	24	12	36	2.25



BLANK STANDARDS

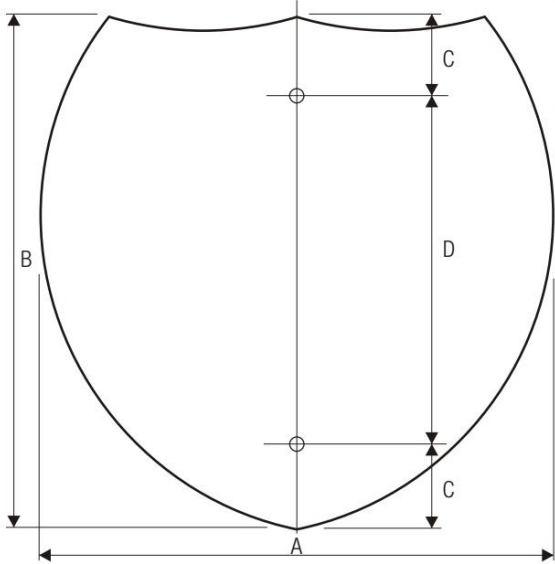

INTERSTATE SHIELD

A	B	C	D
24	24	3	18
30	24	3	18
36	36	6	24
45	36	6	24

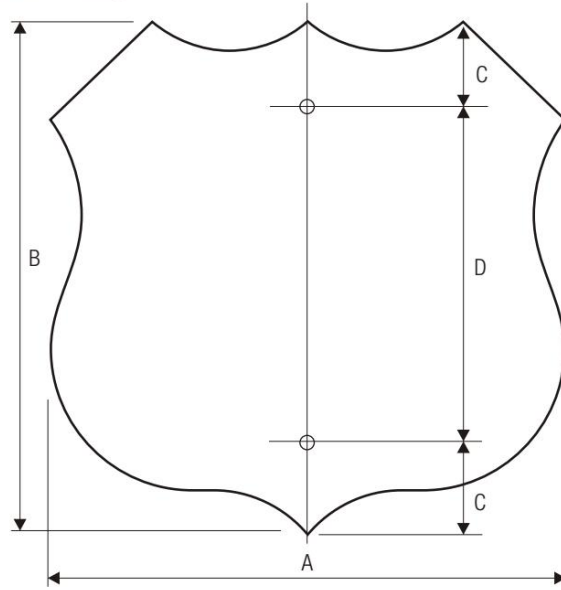

U.S. SHIELD

A	B	C	D
24	24	3	18
30	24	3	18
36	36	6	24
45	36	6	24

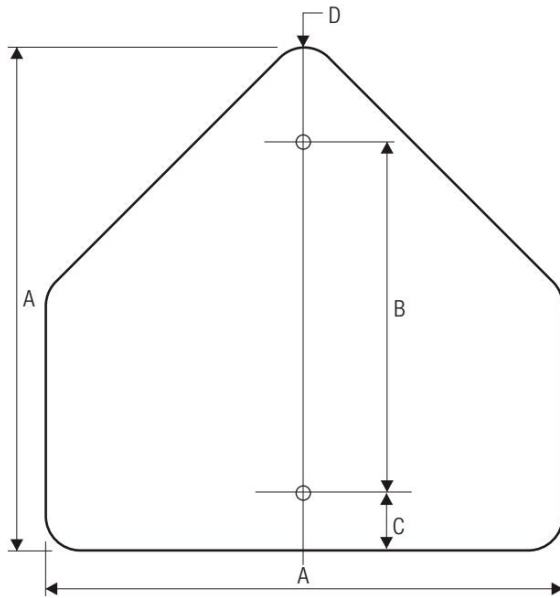

PENTAGON (SCHOOL)

A	B	C	D
30	21	3	1.875
36	24	3	2.25

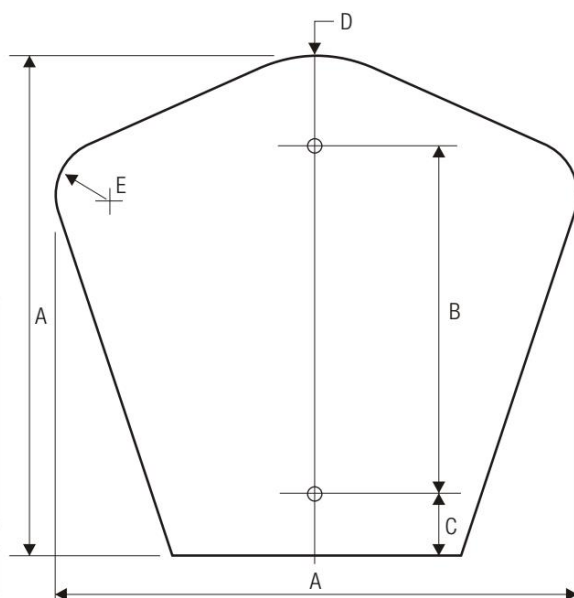

COUNTY SHIELD

A	B	C	D	E
18	15	1	5	2
24	18	2	5.313	2.688
30	24	2	6.625	3.375



## BLANK STANDARDS

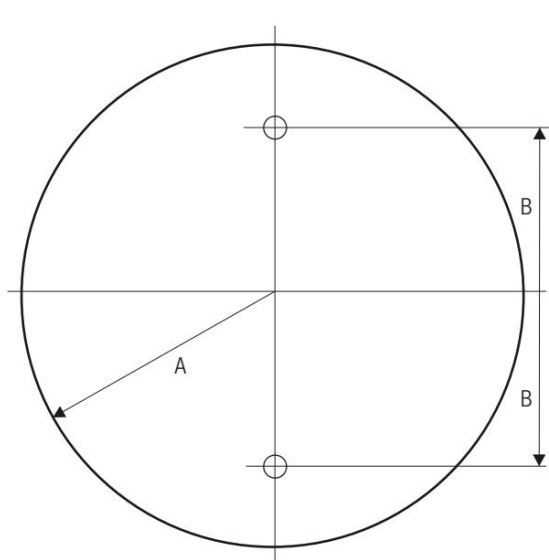

**CIRCLE**

A	B
15	12
18	15

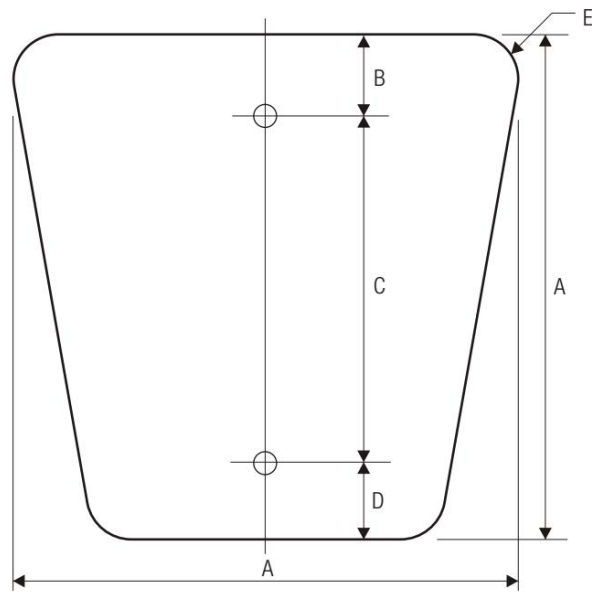

**NATIONAL FOREST SHIELD**

A	B	C	D	E
18	2	15	1	2
24	2.5	20	1.5	2.5

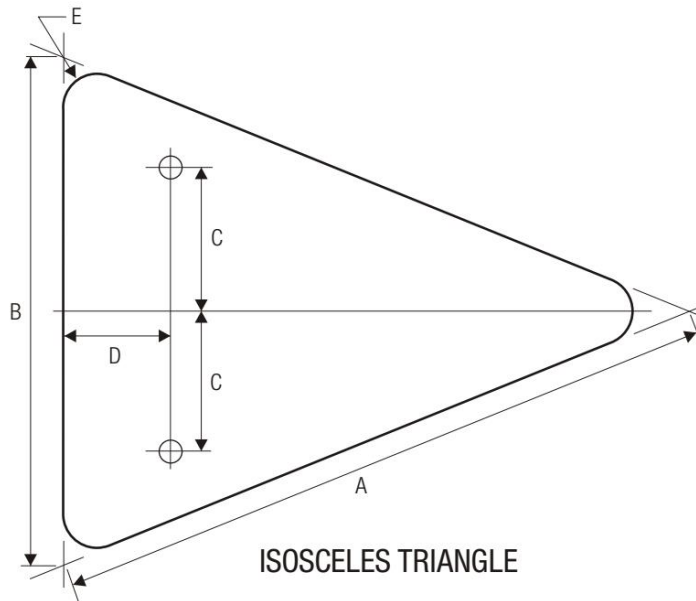

**ISOSCELES TRIANGLE**

A	B	C	D	E
40	30	7.5	12	1.875
48	36	9	15	2.25



**WINDLOAD COORDINATES FOR TELES PAR® AT 90 MPH**  
 (AASHTO Standard Specifications for Structural supports for - Highway Signs, Luminaires and Traffic Signals, 4<sup>th</sup> Edition 2001)

**ALLOWABLE SIGN AREA (FT<sup>2</sup>) PER SINGLE POST\***

SIGN CENTROID	SLIP BASE NOT ALLOWED										MAXIMUM 3 SLIP BASES ALLOWED IN 7' SPAN							
	FHWA APPROVED FOR: 2 POSTS PER SIGN					1 POST PER SIGN		SLIP BASE OPTIONAL**		SLIP BASE REQUIRED								
	1½" x 12 ga perf.	1½" x 14 ga perf.	1½" x 12 ga perf.	2" x 14 ga perf.	2" x 12 ga perf.	2½" x 14 ga perf.	2½" x 12 ga. Perf.	2-3/16 x 10 ga perf.	2½" x 12 ga perf.	2½" x 10 ga perf.	2½" x 12 ga perf.	2½" x 10 ga perf.	2-3/16 x 10 ga perf.	3" x 8 ga solid	3" x 7 ga solid			
16.5'	3.46	3.90	4.85	5.19	6.48	6.67	8.34	9.03	10.44	12.04	18.78	21.07	25.45	28.57				
16'	3.57	4.02	5.00	5.36	6.68	6.88	8.60	9.31	10.76	12.41	19.36	21.73	26.24	29.46				
15.5'	3.68	4.15	5.17	5.53	6.90	7.11	8.88	9.61	11.11	12.82	19.99	22.43	27.09	30.41				
15'	3.81	4.29	5.34	5.71	7.13	7.34	9.17	9.93	11.48	13.24	20.65	23.18	27.99	31.43				
14.5'	3.94	4.44	5.52	5.91	7.37	7.60	9.49	10.28	11.87	13.70	21.36	23.97	28.96	32.51				
14'	4.08	4.59	5.72	6.12	7.64	7.87	9.83	10.64	12.30	14.19	22.13	24.83	29.99	33.67				
13.5'	4.23	4.76	5.93	6.35	7.92	8.16	10.19	11.04	12.75	14.71	22.95	25.75	31.10	34.92				
13'	4.39	4.95	6.16	6.59	8.22	8.47	10.59	11.46	13.24	15.28	23.83	26.74	32.30	36.26				
12.5'	4.57	5.15	6.41	6.86	8.55	8.81	11.01	11.92	13.77	15.89	24.78	27.81	33.59	37.71				
12'	4.76	5.36	6.67	7.14	8.91	9.18	11.47	12.42	14.35	16.55	25.82	28.97	34.99	39.28				
11.5'	4.96	5.59	6.96	7.45	9.30	9.58	11.97	12.96	14.97	17.27	26.94	30.23	36.51	40.99				
11'	5.19	5.85	7.28	7.79	9.72	10.01	12.51	13.54	15.65	18.06	28.16	31.6	38.17	42.85				
10.5'	5.44	6.13	7.63	8.16	10.18	10.49	13.11	14.19	16.40	18.92	29.50	33.11	39.99	44.89				
10'	5.71	6.43	8.01	8.57	10.69	11.01	13.76	14.90	17.22	19.86	30.98	34.76	41.99	47.14				
9.5'	6.01	6.77	8.43	9.02	11.25	11.59	14.49	15.68	18.12	20.91	32.61	36.59	44.20	49.62				
9'	6.34	7.15	8.90	9.52	11.88	12.24	15.29	16.55	19.13	22.07	34.42	38.63	46.65	52.38				
8.5'	6.72	7.57	9.42	10.08	12.58	12.96	16.19	17.53	20.26	23.37	36.45	40.90	49.40	55.46				
8'	7.14	8.04	10.01	10.71	13.36	13.77	17.20	18.62	21.52	24.83	38.72	43.45	52.48	58.92				

\* USE A MULTIPLIER OF 2 OR 3 FOR 2 & 3 POST INSTALLATIONS.  
 \*\* SLIP BASE REQUIRED ON 2 & 3 POST INSTALLATION.





**WINDLOAD COORDINATES FOR TELESAR® AT 100 MPH**  
 (AASHTO Standard Specifications for Structural supports for - Highway Signs, Luminaires and Traffic Signals. 4<sup>th</sup> Edition 2001)

SIGN CENTROID	ALLOWABLE SIGN AREA (FT <sup>2</sup> ) PER SINGLE POST*										MAXIMUM 3 SLIP BASES ALLOWED IN 7' SPAN					
	SLIP BASE NOT ALLOWED										SLIP BASE REQUIRED					
	FHWA APPROVED FOR: 2 POSTS PER SIGN					1 POST PER SIGN					SLIP BASE OPTIONAL**		SLIP BASE REQUIRED			
	1 1/2" x 12 ga perf.	1 3/4" x 14 ga perf.	1 3/4" x 12 ga perf.	2" x 14 ga perf.	2" x 12 ga perf.	2 1/4" x 14 ga perf.	2 1/4" x 12 ga perf.	2-3/16 x 10 ga perf.	2 1/2" x 12 ga perf.	2 1/2" x 10 ga perf.	2 1/2" x 12 ga perf.	2-3/16 x 10 ga perf.	2 1/2" x 10 ga perf.	2 1/2" x 12 ga perf.	3" x 8 ga solid	3" x 7 ga solid
16.5'	2.77	3.12	3.89	4.16	5.20	5.35	6.70	7.26	8.39	9.69	15.10	16.96	20.54	23.07		
16'	2.85	3.21	4.01	4.29	5.36	5.52	6.91	7.49	8.66	10.00	15.57	17.48	21.18	23.79		
15.5'	2.95	3.32	4.14	4.43	5.54	5.70	7.13	7.73	8.94	10.32	16.07	18.05	21.87	24.56		
15'	3.04	3.43	4.28	4.58	5.72	5.89	7.37	7.99	9.23	10.66	16.61	18.65	22.59	25.38		
14.5'	3.15	3.55	4.43	4.73	5.92	6.09	7.63	8.26	9.55	11.03	17.18	19.29	23.37	26.25		
14'	3.26	3.67	4.58	4.90	6.13	6.31	7.90	8.56	9.89	11.42	17.79	19.98	24.21	27.19		
13.5'	3.38	3.81	4.75	5.08	6.36	6.54	8.19	8.88	10.26	11.85	18.45	20.72	25.11	28.20		
13'	3.51	3.96	4.94	5.28	6.60	6.80	8.51	9.22	10.65	12.30	19.16	21.52	26.07	29.28		
12.5'	3.65	4.11	5.13	5.49	6.87	7.07	8.85	9.59	11.08	12.79	19.93	22.38	27.11	30.45		
12'	3.80	4.28	5.35	5.72	7.15	7.36	9.22	9.99	11.54	13.33	20.76	23.31	28.24	31.72		
11.5'	3.97	4.47	5.58	5.97	7.46	7.68	9.62	10.42	12.04	13.91	21.66	24.33	29.47	33.10		
11'	4.15	4.67	5.83	6.24	7.80	8.03	10.05	10.89	12.59	14.54	22.64	25.43	30.81	34.61		
10.5'	4.35	4.90	6.11	6.54	8.17	8.41	10.53	11.41	13.19	15.23	23.72	26.64	32.28	36.25		
10'	4.57	5.14	6.42	6.86	8.58	8.83	11.06	11.98	13.85	15.99	24.91	27.98	33.89	38.07		
9.5'	4.81	5.41	6.75	7.23	9.03	9.30	11.64	12.61	14.58	16.83	26.22	29.45	35.68	40.07		
9'	5.07	5.71	7.13	7.63	9.54	9.82	12.29	13.31	15.39	17.77	27.68	31.08	37.66	42.30		
8.5'	5.37	6.05	7.55	8.08	10.10	10.39	13.01	14.10	16.29	18.81	29.30	32.91	39.87	44.78		
8'	5.71	6.43	8.02	8.58	10.73	11.04	13.82	14.98	17.31	19.99	31.14	34.97	42.37	47.58		

\* USE A MULTIPLIER OF 2 OR 3 FOR 2 & 3 POST INSTALLATIONS.  
 \*\* SLIP BASE REQUIRED ON 2 & 3 POST INSTALLATION.



**WINDLOAD COORDINATES FOR TELLESPAR® AT 110 MPH**  
(AASHTO Standard Specifications for Structural supports for - Highway Signs, Luminaires and Traffic Signals, 4<sup>th</sup> Edition 2001)

**ALLOWABLE SIGN AREA (FT<sup>2</sup>) PER SINGLE POST\***

SIGN CENTROID	SLIP BASE NOT ALLOWED										MAXIMUM 3 SLIP BASES ALLOWED IN 7' SPAN									
	FHWA APPROVED FOR: 2 POSTS PER SIGN					1 POST PER SIGN					SLIP BASE OPTIONAL**					SLIP BASE REQUIRED				
	1½" x 12 ga perf.	1½" x 14 ga perf.	1½" x 12 ga perf.	2" x 14 ga perf.	2" x 12 ga perf.	2½" x 14 ga perf.	2½" x 12 ga perf.	2-3/16 x 10ga perf.	2½" x 12 ga perf.	2½" x 10 ga perf.	2½" x 12 ga perf.	2-3/16x10 ga perf.	2½" x 12 ga perf.	2-3/16x10 ga perf.	3" x 8 ga solid	3" x 7 ga solid				
16.5'	2.25	2.54	3.18	3.40	4.26	4.38	5.49	5.96	6.88	7.96	12.37	13.91	16.91	19.00						
16'	2.33	2.62	3.28	3.50	4.39	4.51	5.66	6.14	7.10	8.21	12.76	14.35	17.44	19.60						
15.5'	2.40	2.70	3.38	3.61	4.53	4.66	5.85	6.34	7.33	8.47	13.17	14.81	18.00	20.23						
15'	2.48	2.79	3.49	3.73	4.68	4.81	6.04	6.55	7.57	8.75	13.61	15.30	18.60	20.90						
14.5'	2.57	2.89	3.61	3.86	4.84	4.98	6.25	6.78	7.83	9.05	14.08	15.83	19.24	21.62						
14'	2.66	2.99	3.74	4.00	5.02	5.16	6.47	7.02	8.11	9.38	14.58	16.40	19.93	22.40						
13.5'	2.76	3.10	3.88	4.15	5.20	5.35	6.71	7.28	8.41	9.72	15.12	17.00	20.67	23.22						
13'	2.86	3.22	4.03	4.31	5.40	5.55	6.97	7.56	8.74	10.10	15.71	17.66	21.46	24.12						
12.5'	2.98	3.35	4.19	4.48	5.62	5.78	7.25	7.86	9.09	10.50	16.33	18.36	22.32	25.08						
12'	3.10	3.49	4.37	4.67	5.85	6.02	7.55	8.19	9.46	10.94	17.01	19.13	23.25	26.13						
11.5'	3.23	3.64	4.56	4.87	6.11	6.28	7.88	8.54	9.88	11.42	17.75	19.96	24.26	27.26						
11'	3.38	3.81	4.76	5.09	6.38	6.56	8.24	8.93	10.32	11.93	18.56	20.87	25.37	28.50						
10.5'	3.54	3.99	4.99	5.34	6.69	6.88	8.63	9.36	10.82	12.50	19.45	21.86	26.57	29.86						
10'	3.72	4.19	5.24	5.60	7.02	7.22	9.06	9.83	11.36	13.13	20.42	22.95	27.90	31.35						
9.5'	3.92	4.41	5.52	5.90	7.39	7.60	9.54	10.34	11.96	13.82	21.49	24.16	29.37	33.00						
9'	4.13	4.65	5.82	6.22	7.80	8.02	10.07	10.92	12.62	14.59	22.69	25.50	31.00	34.84						
8.5'	4.38	4.93	6.17	6.59	8.26	8.49	10.66	11.56	13.36	15.45	24.02	27.01	32.83	36.89						
8'	4.65	5.23	6.55	7.00	8.78	9.03	11.33	12.28	14.20	16.41	25.52	28.69	34.88	39.19						

\* USE A MULTIPLIER OF 2 OR 3 FOR 2 & 3 POST INSTALLATIONS.  
\*\* SLIP BASE REQUIRED ON 2 & 3 POST INSTALLATION.





**WINDLOAD COORDINATES FOR TELESAR® AT 120 MPH**  
 (AASHTO Standard Specifications for Structural supports for - Highway Signs, Luminaires and Traffic Signals, 4<sup>th</sup> Edition 2001)

**ALLOWABLE SIGN AREA (FT<sup>2</sup>) PER SINGLE POST\***

SIGN CENTROID	SLIP BASE NOT ALLOWED										MAXIMUM 3 SLIP BASES ALLOWED IN 7' SPAN									
	FHWA APPROVED FOR: 2 POSTS PER SIGN										1 POST PER SIGN		SLIP BASE OPTIONAL**			SLIP BASE REQUIRED				
	1 1/2" x 12 ga perf.	1 3/4" x 14 ga perf.	1 3/4" x 12 ga perf.	2" x 14 ga perf.	2" x 12 ga perf.	2 1/4" x 14 ga perf.	2 1/4" x 12 ga perf.	2 1/2" x 14 ga perf.	2 1/2" x 12 ga perf.	2 3/16 x 10 ga perf.	2 1/2" x 12 ga perf.	2 1/2" x 10 ga perf.	2 1/2" x 12 ga perf.	2 3/16 x 10 ga perf.	2 1/2" x 12 ga perf.	2 1/2" x 10 ga perf.	2 3/16 x 10 ga perf.	3" x 8 ga solid	3" x 7 ga solid	
16.5'	1.86	2.10	2.63	2.81	3.54	3.63	4.57	4.96	5.73	6.64	10.30	11.60	14.15	15.91						
16'	1.92	2.16	2.72	2.90	3.65	3.75	4.71	5.12	5.91	6.84	10.63	11.96	14.59	16.40						
15.5'	1.99	2.23	2.80	2.99	3.76	3.87	4.86	5.28	6.10	7.06	10.97	12.35	15.06	16.93						
15'	2.05	2.31	2.90	3.09	3.89	4.00	5.03	5.46	6.31	7.30	11.33	12.76	15.57	17.50						
14.5'	2.12	2.39	3.00	3.20	4.02	4.13	5.20	5.64	6.53	7.55	11.73	13.20	16.10	18.10						
14'	2.20	2.47	3.11	3.32	4.17	4.28	5.39	5.85	6.76	7.82	12.14	13.67	16.68	18.75						
13.5'	2.28	2.56	3.22	3.44	4.32	4.44	5.58	6.06	7.01	8.11	12.59	14.17	17.30	19.44						
13'	2.37	2.66	3.34	3.57	4.49	4.61	5.80	6.30	7.28	8.42	13.08	14.72	17.96	20.19						
12.5'	2.46	2.77	3.48	3.71	4.67	4.80	6.03	6.55	7.57	8.76	13.60	15.31	18.68	21.00						
12'	2.56	2.88	3.62	3.87	4.86	5.00	6.28	6.82	7.88	9.12	14.17	15.95	19.46	21.87						
11.5'	2.68	3.01	3.78	4.04	5.07	5.21	6.56	7.12	8.23	9.52	14.78	16.64	20.30	22.82						
11'	2.80	3.15	3.95	4.22	5.30	5.45	6.85	7.44	8.60	9.95	15.46	17.40	21.23	23.86						
10.5'	2.93	3.30	4.14	4.42	5.56	5.71	7.18	7.80	9.01	10.43	16.19	18.22	22.24	25.00						
10'	3.08	3.46	4.35	4.64	5.83	5.99	7.54	8.19	9.46	10.95	17.00	19.14	23.35	26.25						
9.5'	3.24	3.64	4.58	4.89	6.14	6.31	7.94	8.62	9.96	11.53	17.90	20.14	24.58	27.63						
9'	3.42	3.85	4.83	5.16	6.48	6.66	8.38	9.09	10.51	12.17	18.89	21.26	25.94	29.16						
8.5'	3.62	4.07	5.11	5.46	6.86	7.05	8.87	9.63	11.13	12.88	20.00	22.51	27.47	30.88						
8'	3.85	4.33	5.43	5.80	7.29	7.49	9.42	10.23	11.83	13.69	21.25	23.92	29.19	32.81						

\* USE A MULTIPLIER OF 2 OR 3 FOR 2 & 3 POST INSTALLATIONS.

\*\* SLIP BASE REQUIRED ON 2 & 3 POST INSTALLATION.



### Example of a Barrier Rail MDSB Saddle Mount Bracket

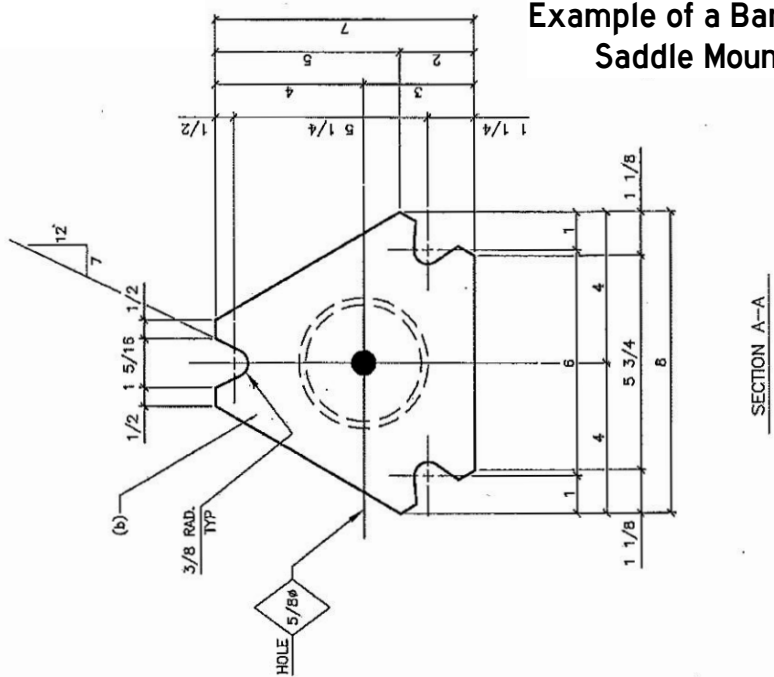

\*GALVANIZE AFTER FAB.

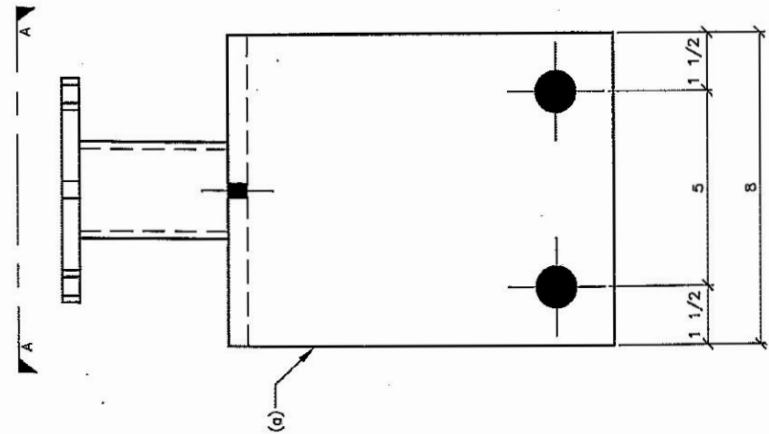
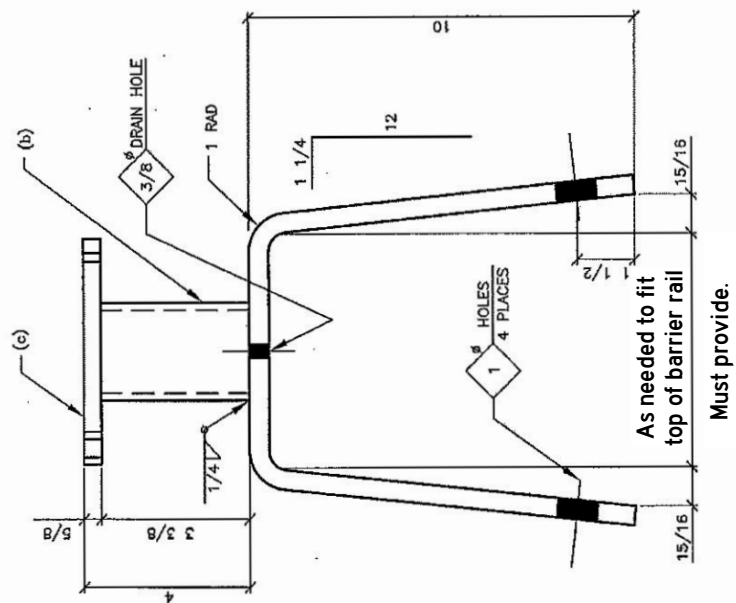

MK	QTY.	MATERIAL DESCRIPTION	LENGTH		WT
			FT.	IN.	
a		PL 3/8 X 8 (BEND)	2	1 1/2	239
b		3ø STD PIPE	0	3 3/8	23
c		PL 5/8 TRIANGLE SLIP BASE	0	7	72
SHIP WEIGHT:					

6" BARRIER SADDLE BRACKET		SCALE: NONE	APPROVED BY:	DRAWN BY: KD
		DATE: 09/20/06	JOB NO:	
UNIVERSAL INDUSTRIAL SALES LINDON, UTAH				
FOR:				DRAWING NO.
				1

# **Clark County Traffic Markings**

## **Pavement Marking and RPM Layouts**



# Proper Direction for a Striping

Striping always points to horizon  
to side you want vehicle to go.

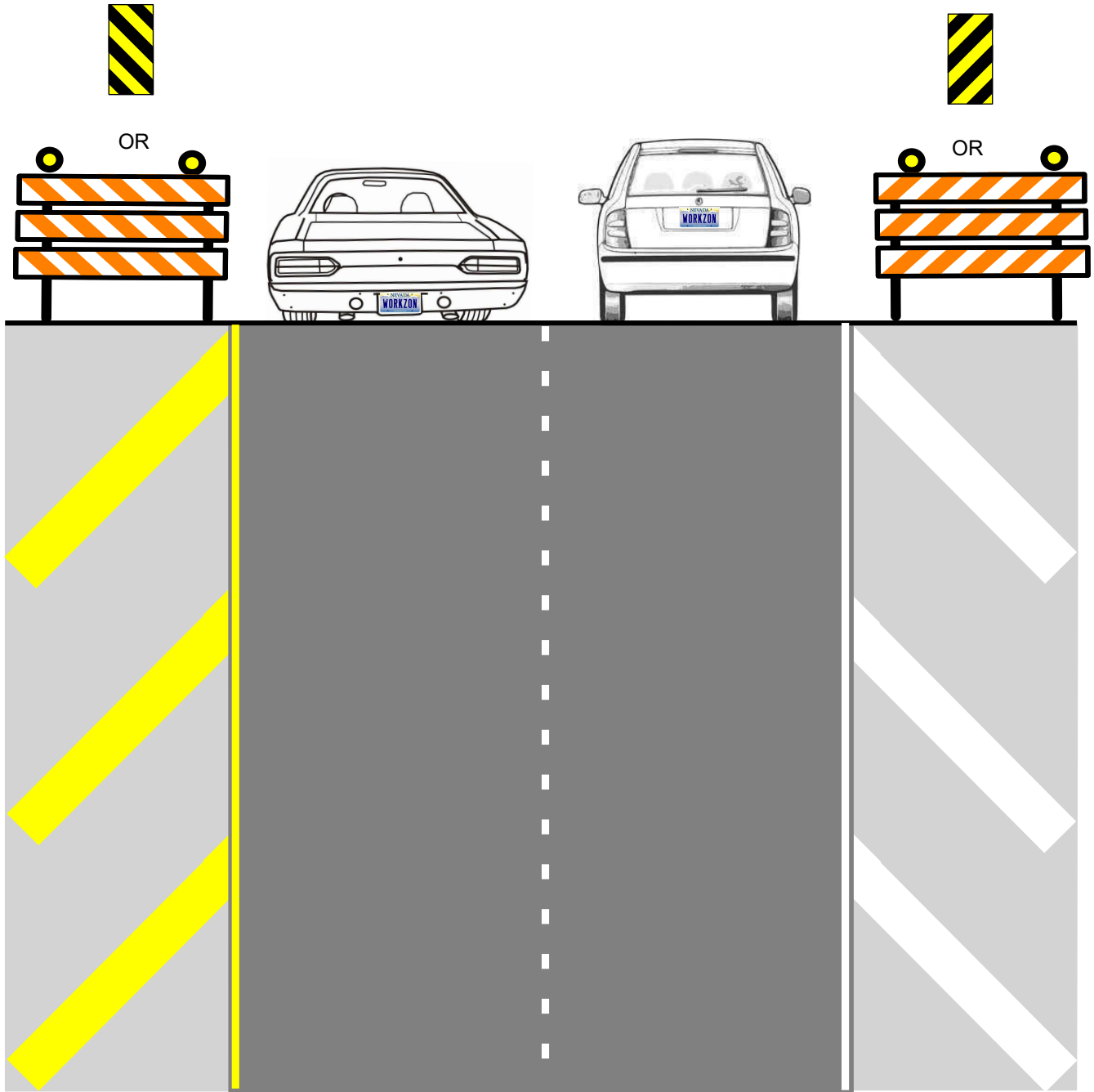

# Proper Direction for Bike Lane Buffer Striping

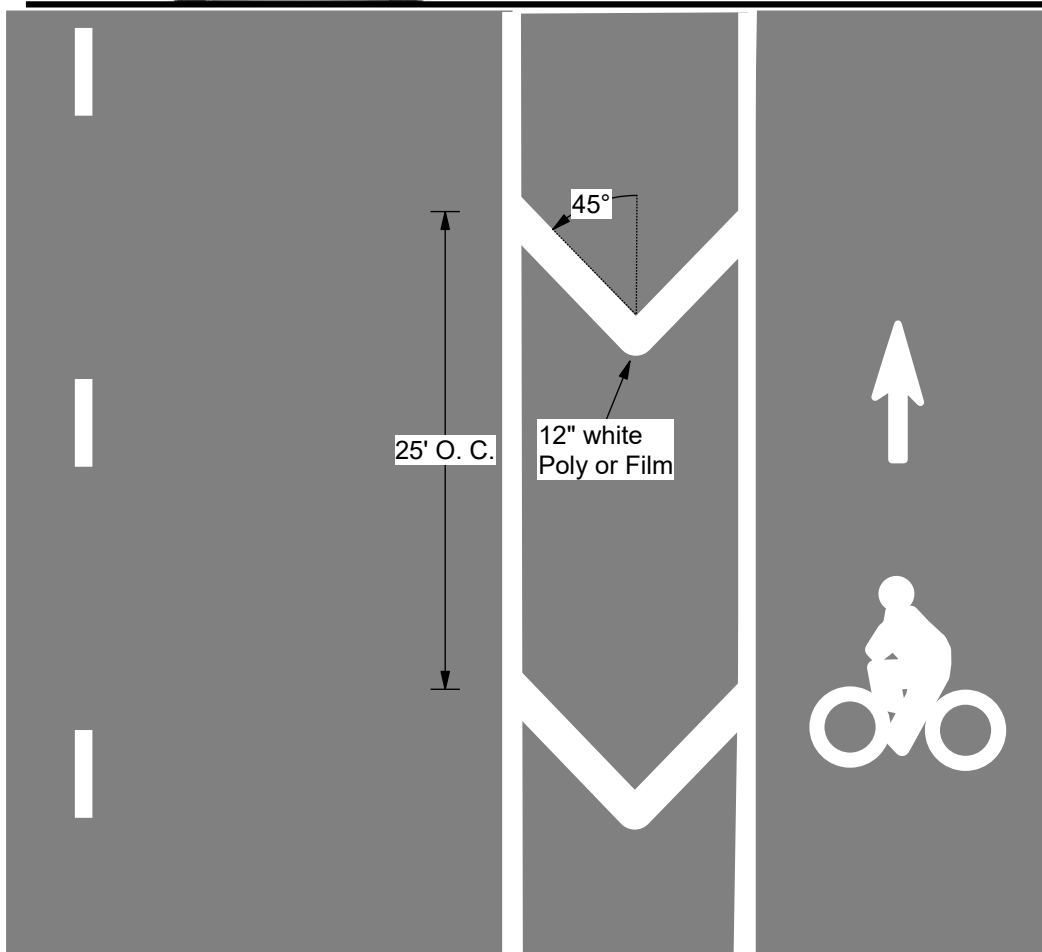

6" Poly or Film Only  
NO RPMS



# Raised Median Marking RPM Outline

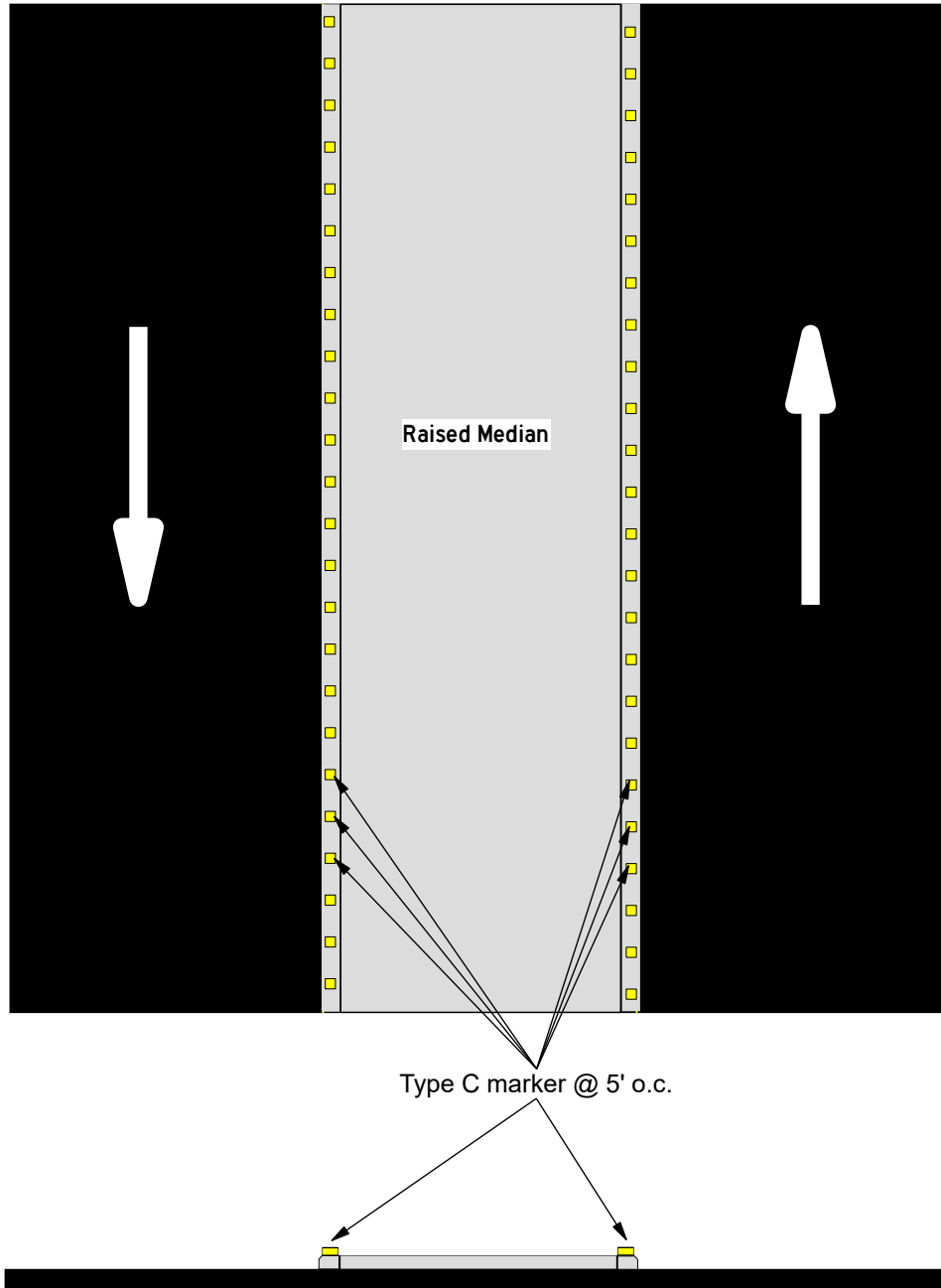

## Two-way Traffic



# Raised Median Marking RPM Outline

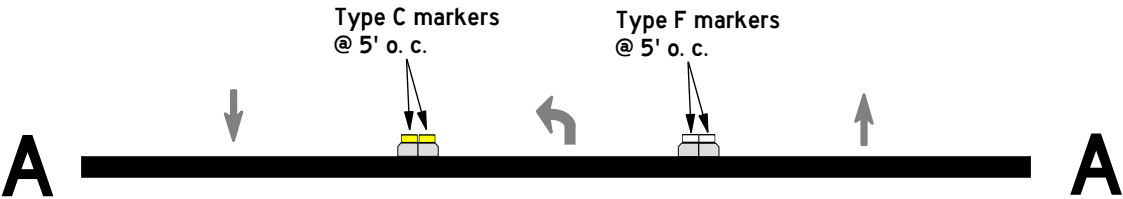
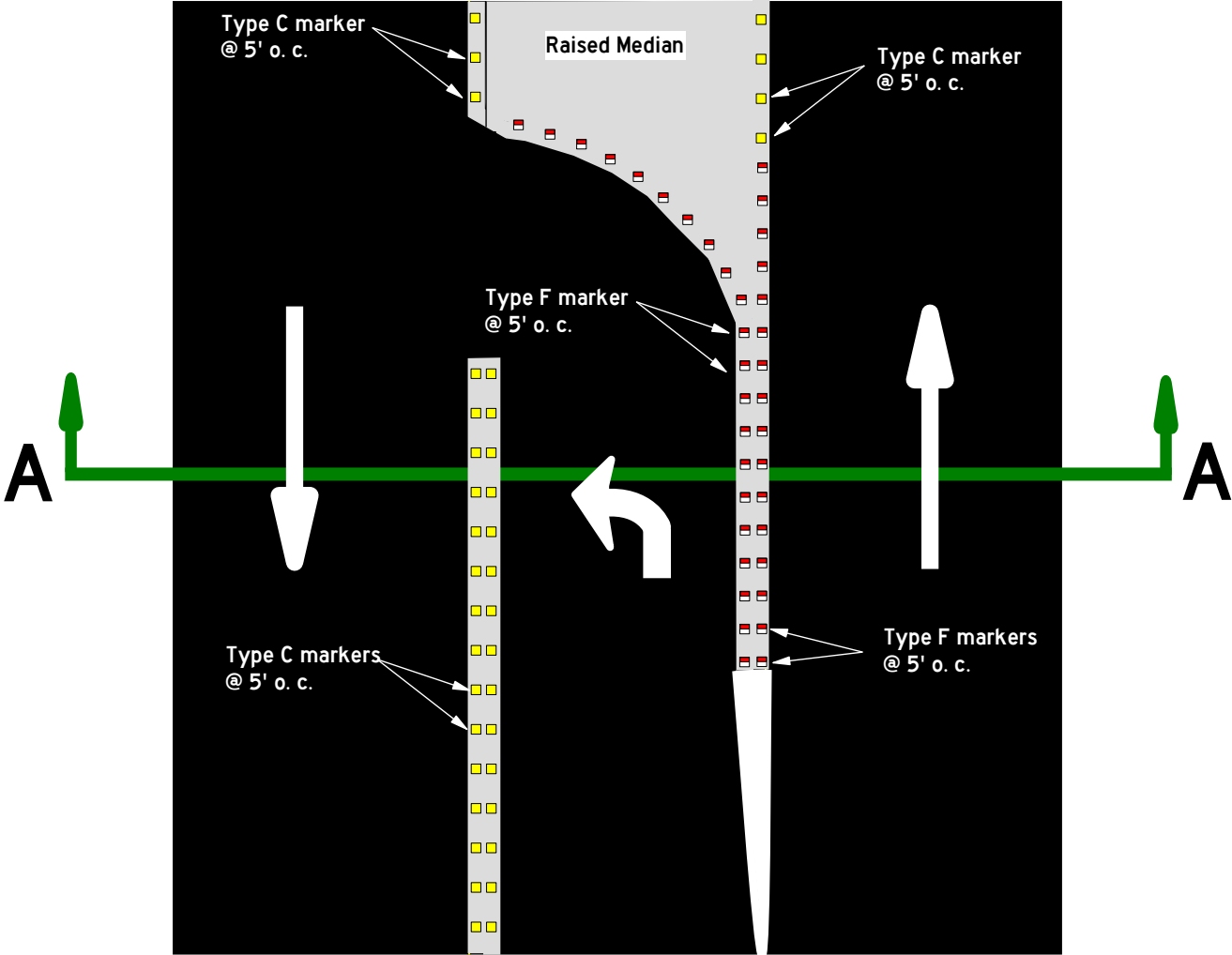

## Turn Pocket



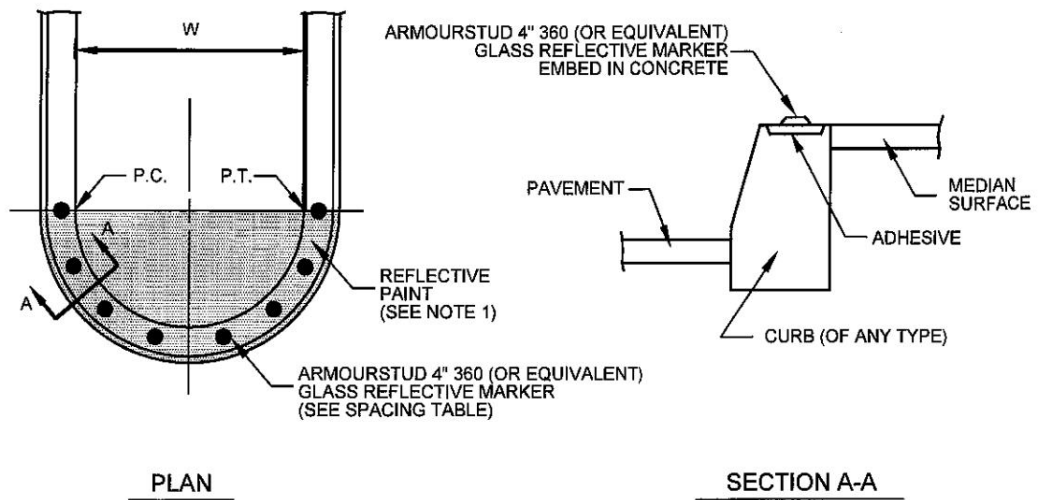

SPACING TABLE

"W"	NUMBER OF REFLECTORS PER MEDIAN NOSE *
1.0' TO 2.0'	3
2.0' TO 3.0'	4
3.0' TO 4.0'	5
4.0' & GREATER	1 EACH FOR EVERY 1.0' OF CURB LENGTH

\* 1 MARKER EACH SHALL BE PLACED ON THE P.C. AND THE P.T. OF THE MEDIAN NOSE; ALL OTHERS SPACED EQUALLY BETWEEN P.T. & P.C.

NOTE:

ENTIRE MEDIAN SHALL BE PAINTED WITH REFLECTIVE PAINT, OF SAME COLOR AS REFLECTIVE MARKERS, FROM THE MEDIAN NOSE BACK 5 FEET OR TO THE P.C., WHICHEVER IS GREATER.

		AGENCY APPROVED	C
SPECIFICATION REFERENCE		UNIFORM STANDARD DRAWINGS CLARK COUNTY AREA	
628	PAINTING TRAFFIC STRIPING	MEDIAN NOSE MARKINGS	
633	REFLECTIVE PAVEMENT MARKERS		





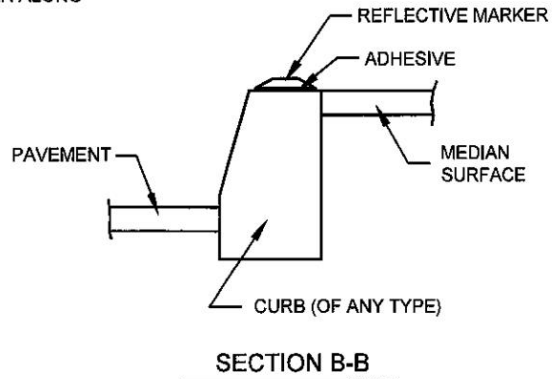
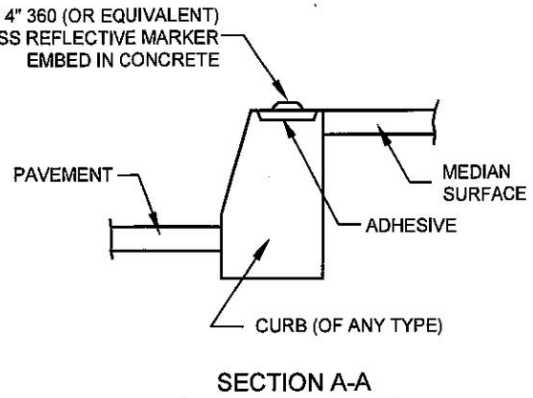
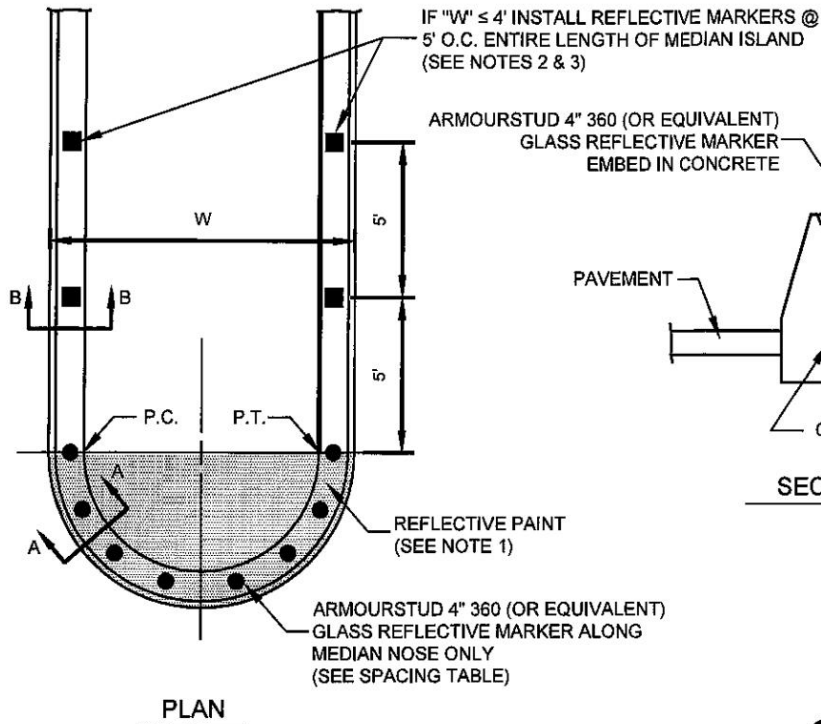

SPACING TABLE

"W"	NUMBER OF REFLECTORS PER MEDIAN NOSE *
1.0' TO 2.0'	3
2.0' TO 3.0'	4
3.0' TO 4.0'	5
4.0' & GREATER	1 EACH FOR EVERY 1.0' OF CURB LENGTH

\* 1 MARKER EACH SHALL BE PLACED ON THE P.C. AND THE P.T. OF THE MEDIAN NOSE; ALL OTHERS SPACED EQUALLY BETWEEN P.T. & P.C.

NOTES:

1. ENTIRE MEDIAN SHALL BE PAINTED WITH REFLECTIVE PAINT, OF SAME COLOR AS REFLECTIVE MARKERS, FROM THE MEDIAN NOSE BACK 5 FEET OR TO THE P.C., WHICHEVER IS GREATER.
2. REFLECTIVE PAVEMENT MARKERS USED ON MEDIAN SHALL CONFORM TO STANDARD DRAWING NO. 247.
3. ORIENTATION OF THE REFLECTIVE MARKERS FACES SHALL BE MADE IN THE FIELD TO ENSURE THAT MARKERS ARE AIMED AT APPROACHING VEHICLES TO BEST ADVANTAGE, ESPECIALLY IN HORIZONTALLY CURVED ROAD SECTIONS.

AGENCY APPROVED

C

SPECIFICATION REFERENCE

CLARK COUNTY PUBLIC WORKS  
STANDARD DETAIL

628	PAINTING TRAFFIC STRIPING
633	REFLECTIVE PAVEMENT MARKERS

MEDIAN ISLAND MARKINGS



# Permanent Barricades



# Correct Striping for Permanent End of Road Type 3 Barricades

(Red and White Striping)

Dead End - No ability to turn

Preferred

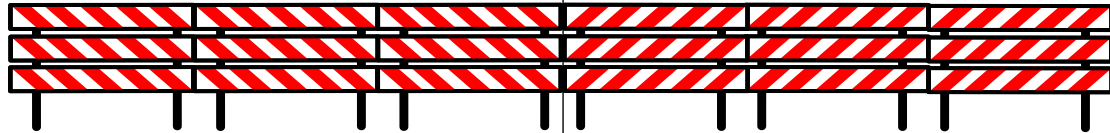

OR

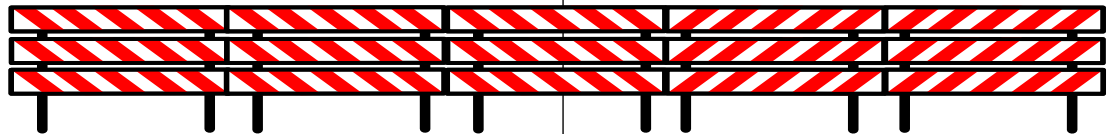

Ability to turn left and right

Preferred

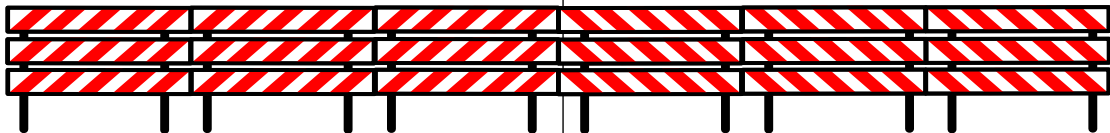

OR

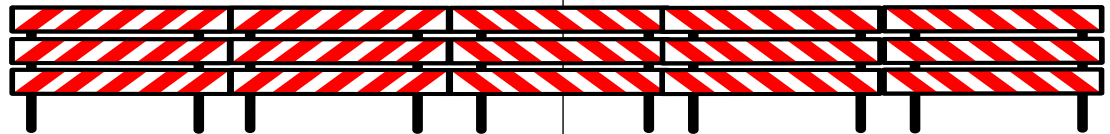

Center Line of Road/Right of Way



# Incorrect Striping for End of Road Type 3 Barricades

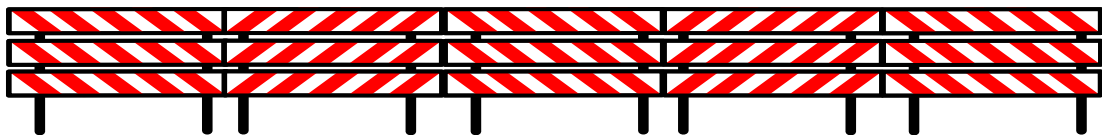
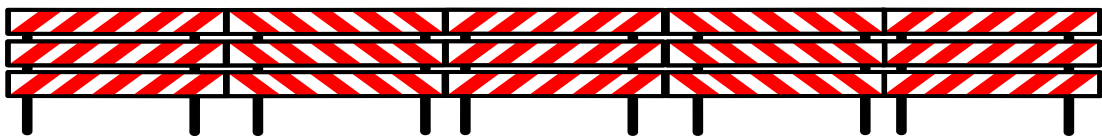
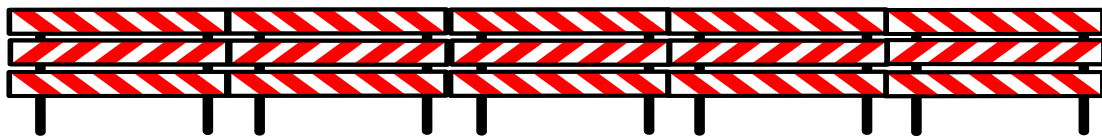
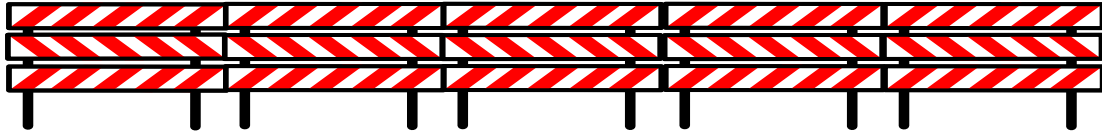



# End of Road Type 3 Barricades Striping Directions Half Street Improvements

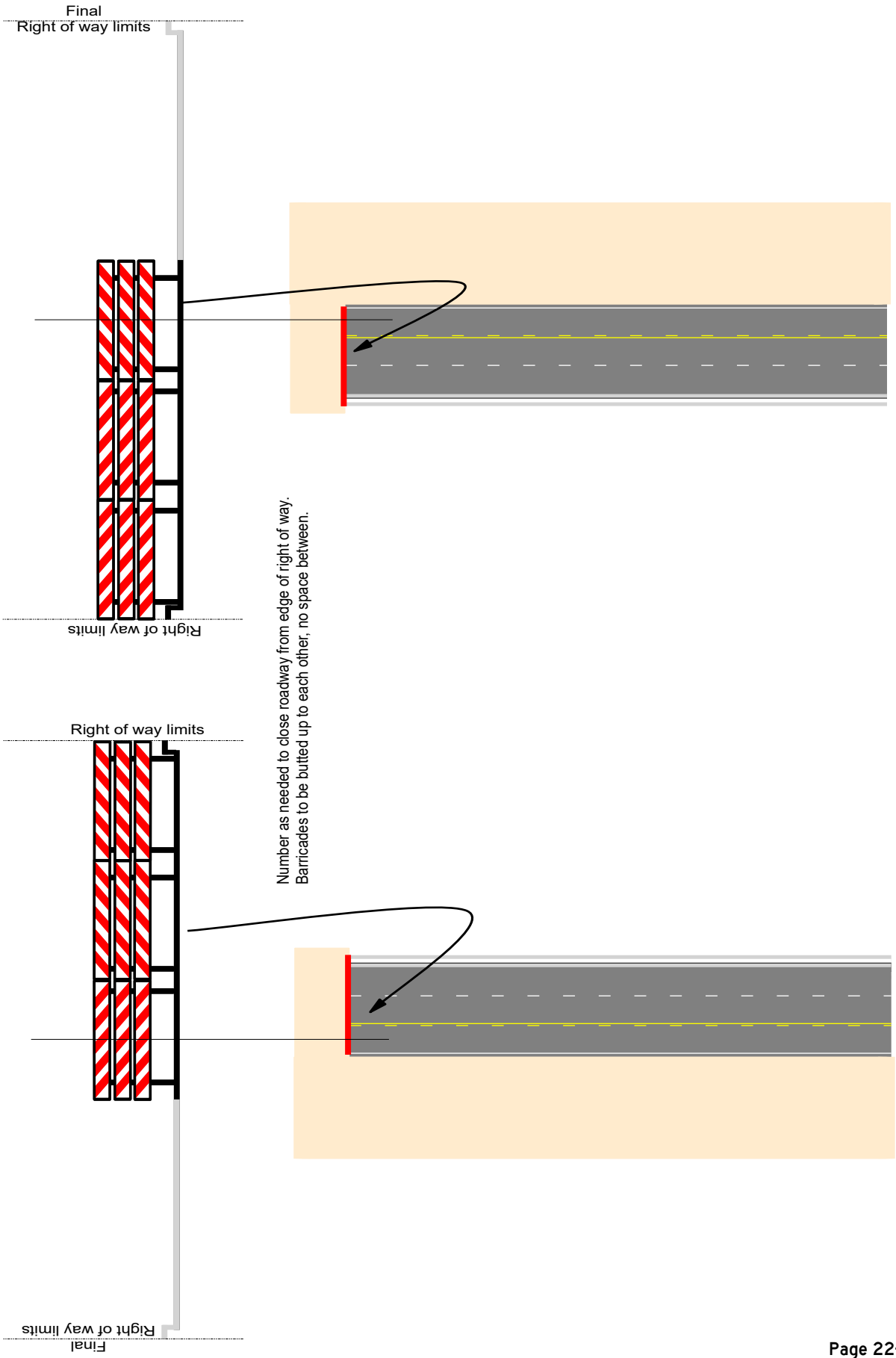

# End of Road Type 3 Barricades Striping Directions Half Street Improvements

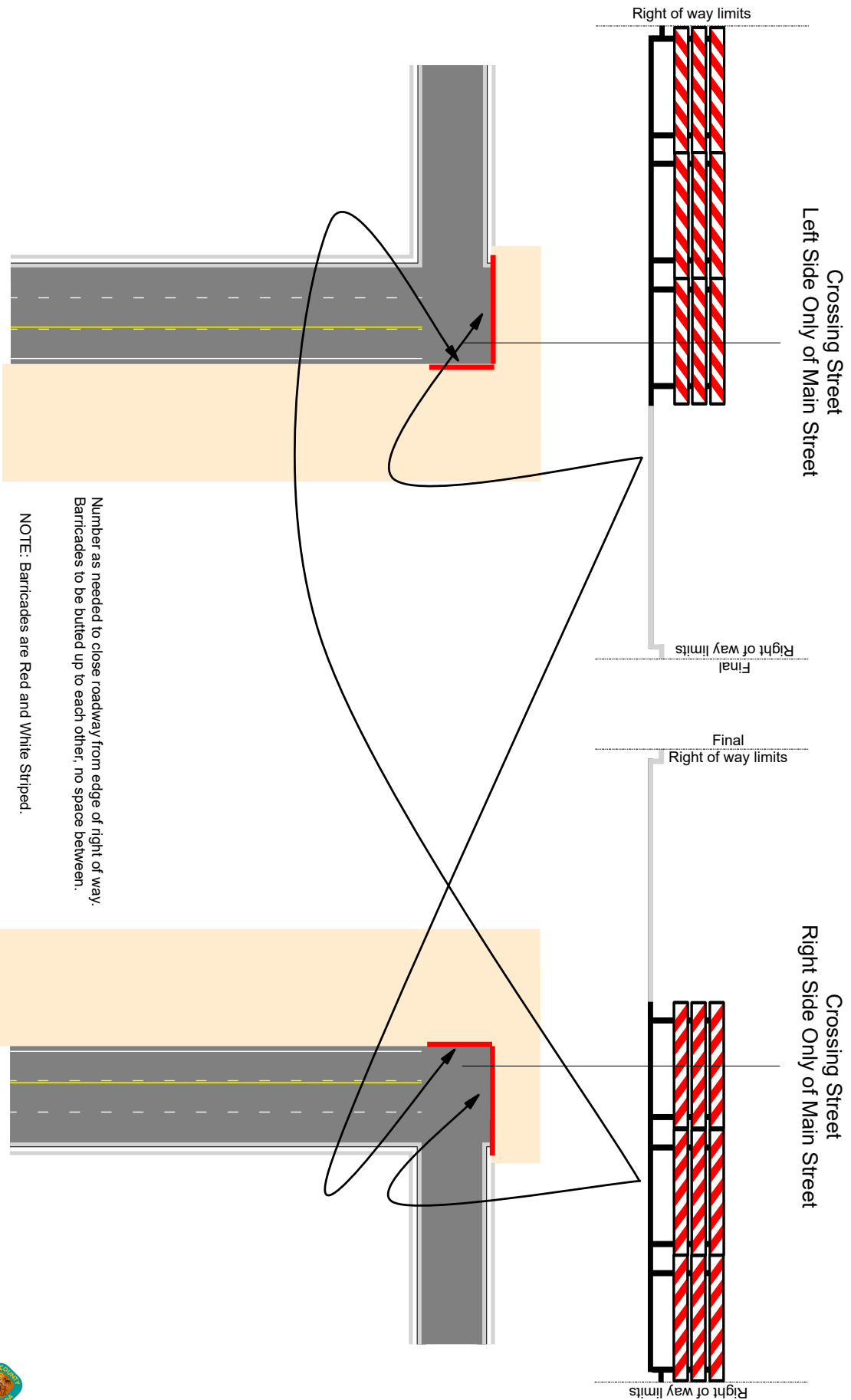

Number as needed to close roadway from edge of right of way.  
Barricades to be butted up to each other, no space between.

NOTE: Barricades are Red and White Striped.





# End of Road Type 3 Barricades Striping Directions

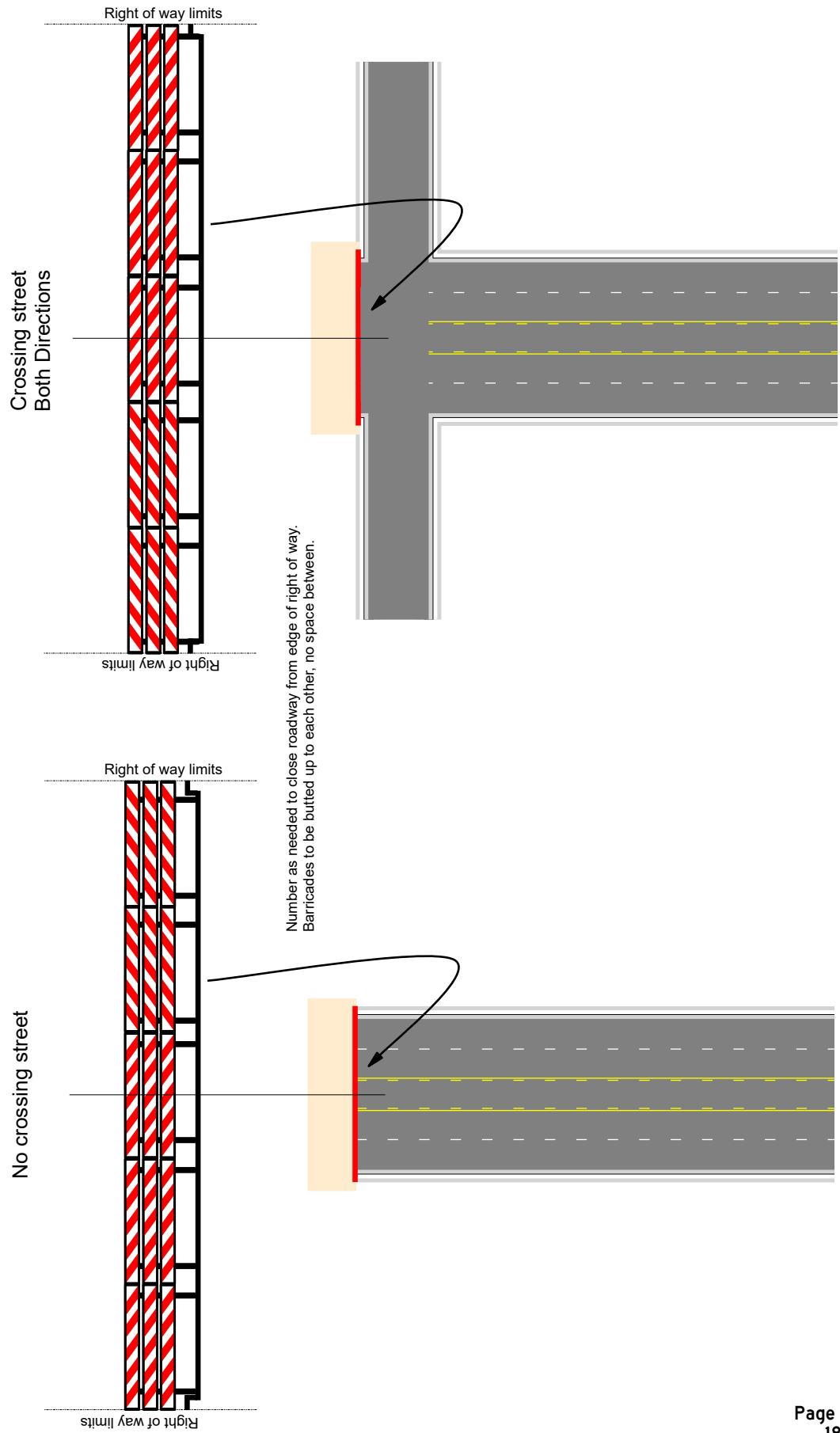



# End of Road Type 3 Barricades Striping Directions

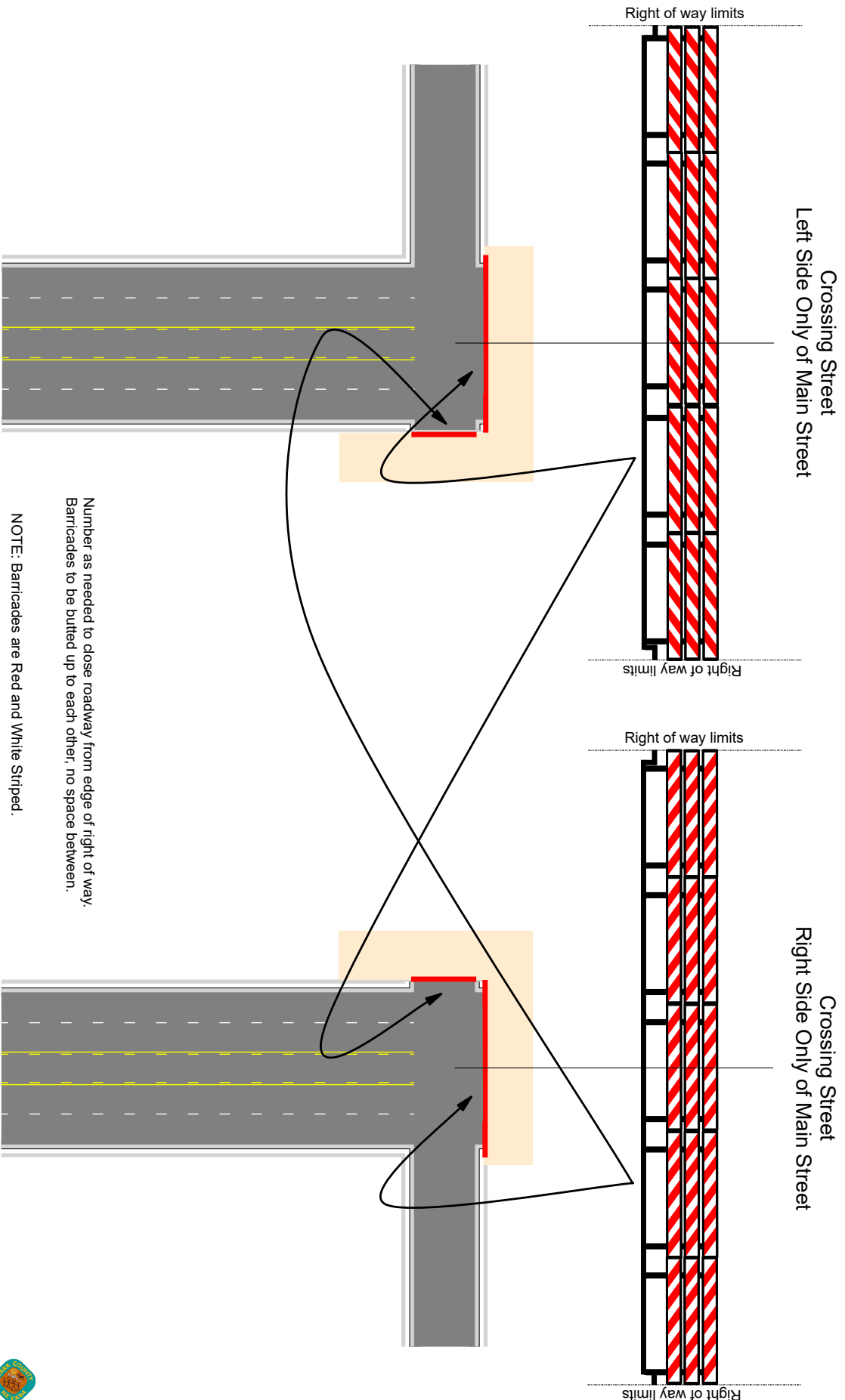

# End of Road Type 3 Barricades Striping Directions ROW less than 70 feet

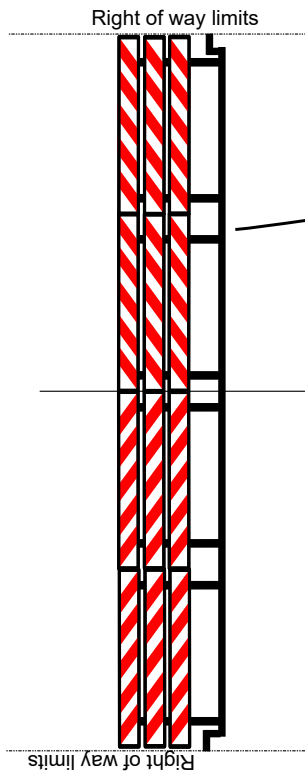
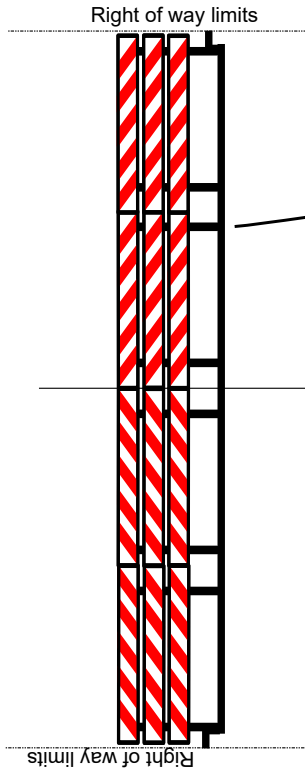

Number as needed to close roadway from edge of right of way.  
Barricades to be butted up to each other, no space between.

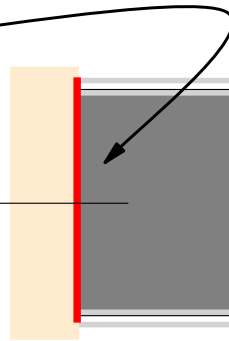
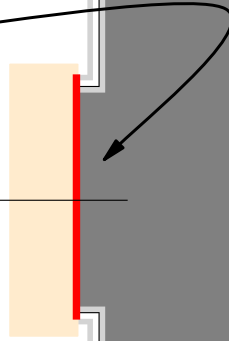

# End of Road Type 3 Barricades Striping Directions Half Street Improvements - ROW less than 70 feet

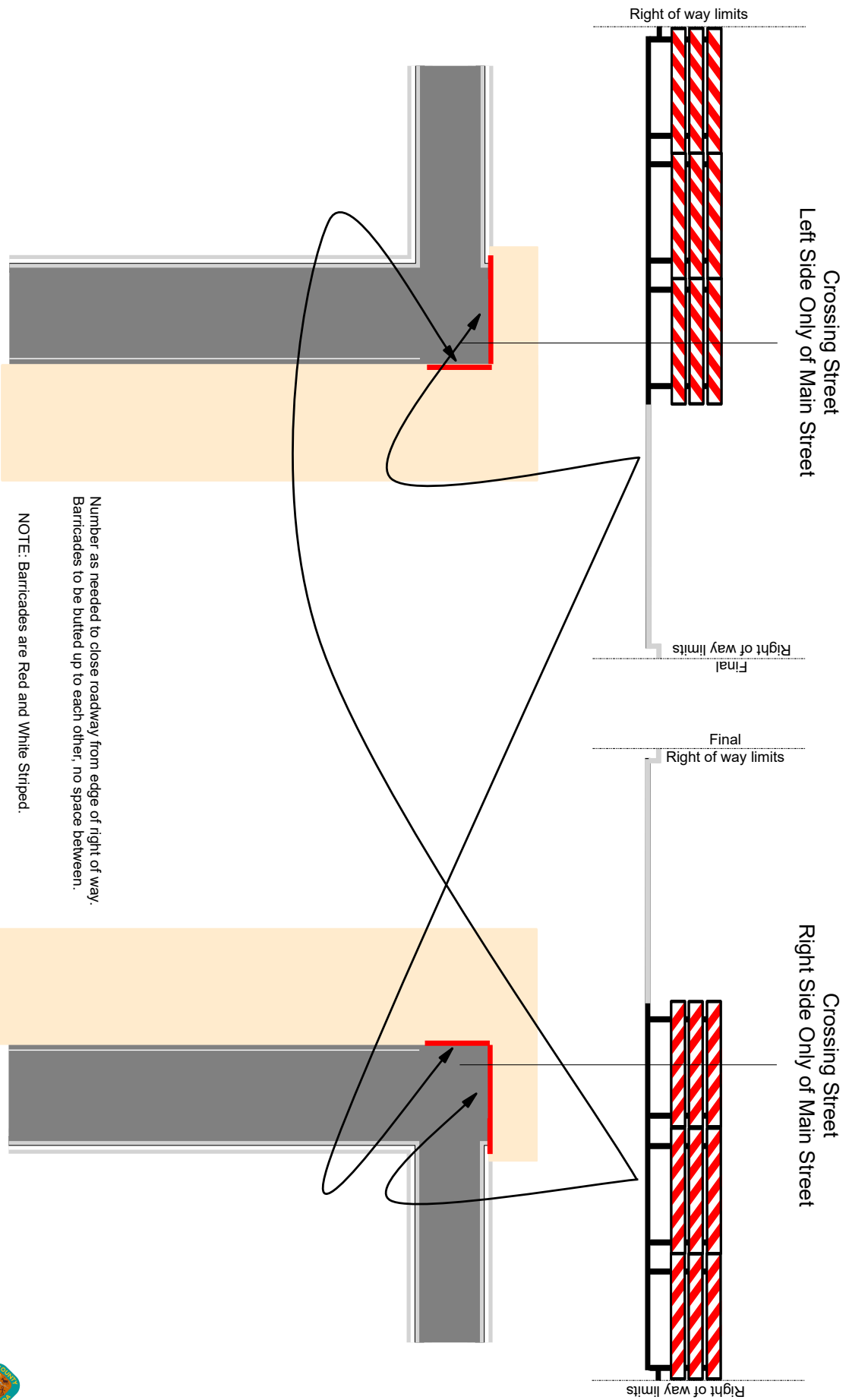

Number as needed to close roadway from edge of right of way.  
Barricades to be butted up to each other, no space between.

NOTE: Barricades are Red and White Striped.



# **Clark County**

# **Special Lane Patterns**



# Special Lane Patterns

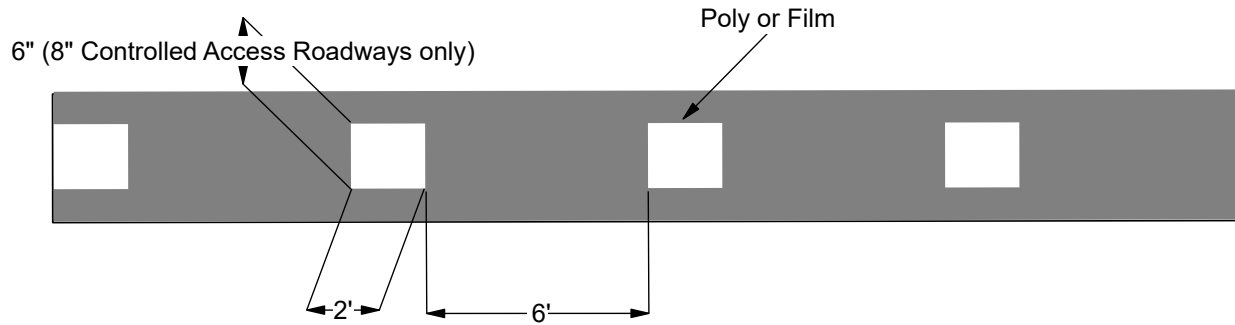

## Skip Line Pattern

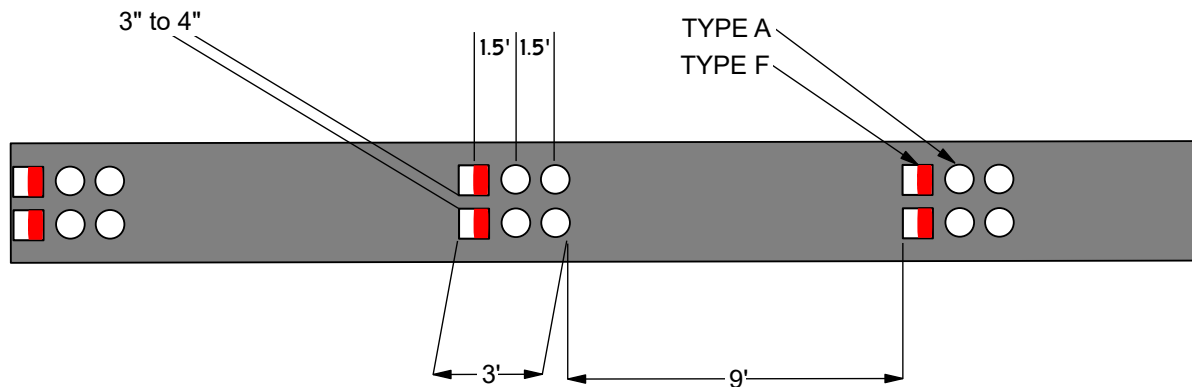
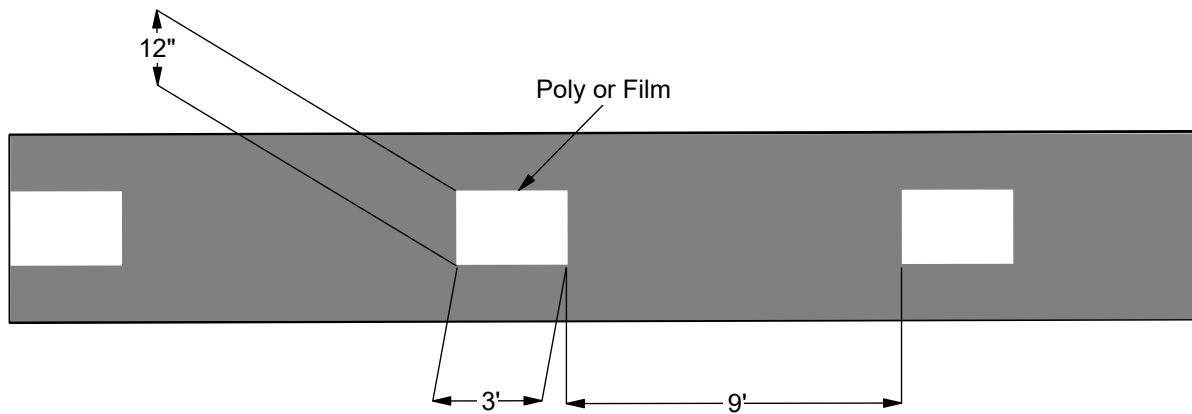

## Drop Line Pattern



# **Clark County Traffic Markings**

## **Controlled Access Facilities**



Note: Striping NOT to be on shoulder.

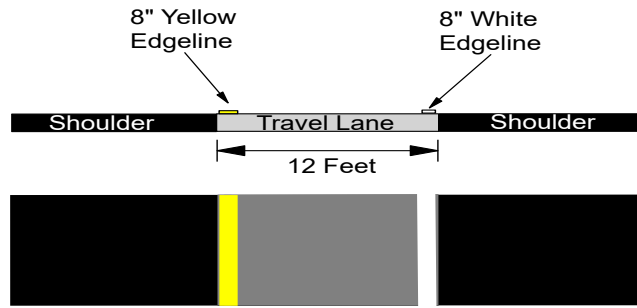

# 1 lane (ramp)

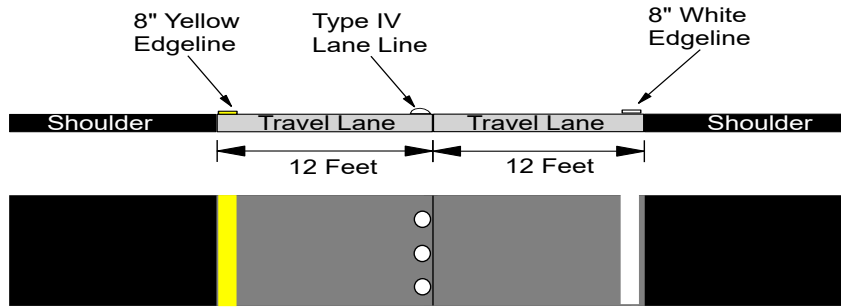

# 2 lanes

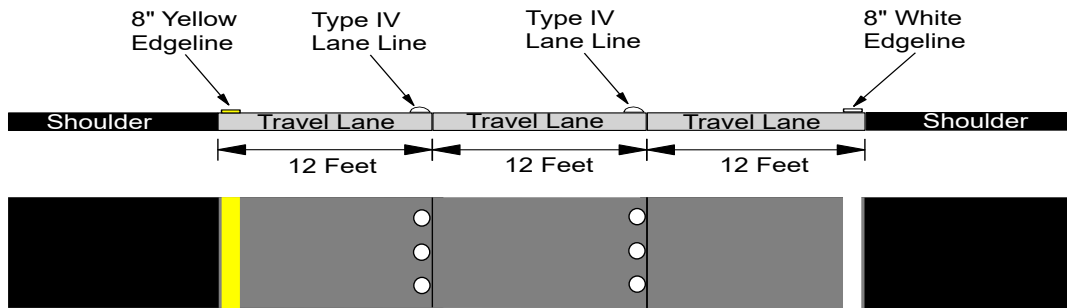

# 3 lanes

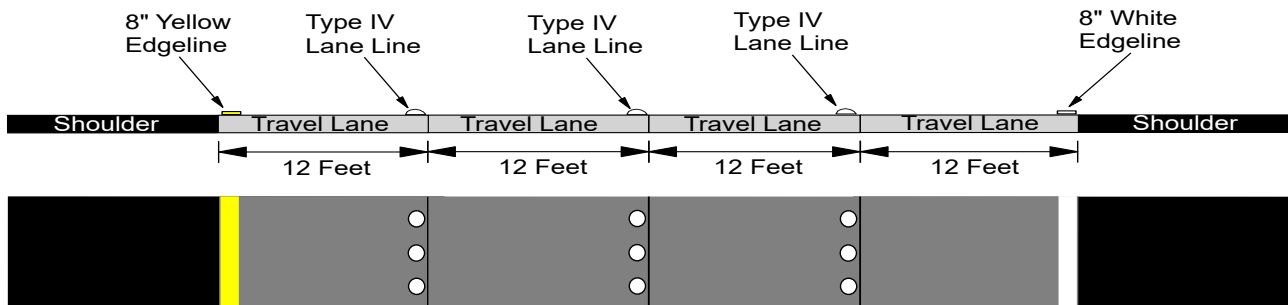

# 4 lanes

# Correct Marking for Controlled Access Facilities

Direction of Travel

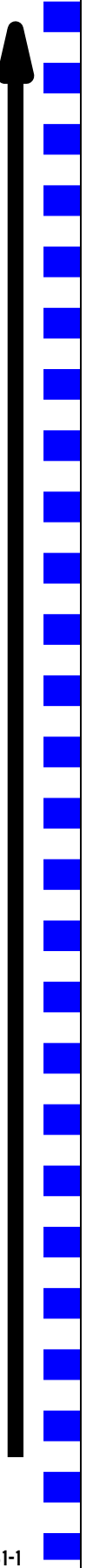

Note: Striping NOT to be on shoulder.

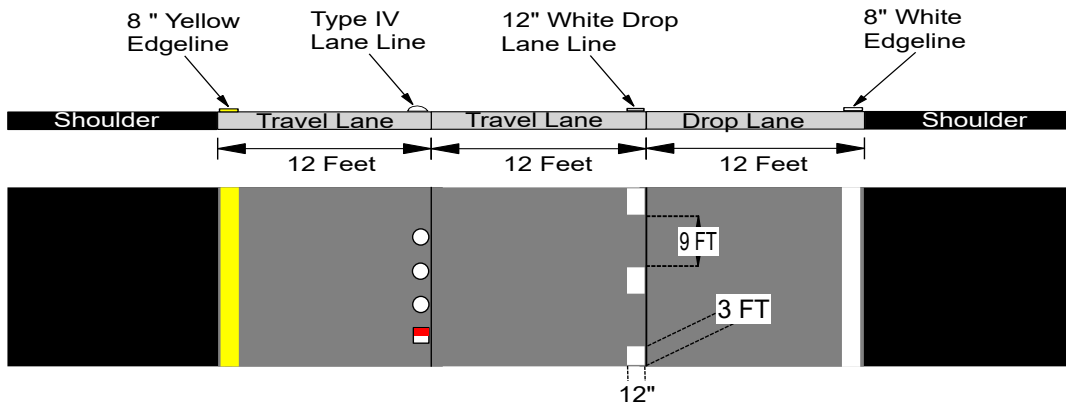

2 lanes plus drop lane

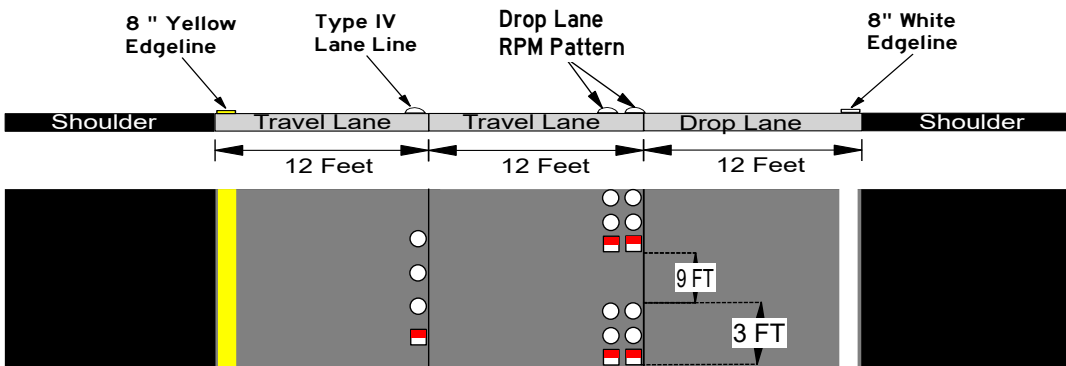

2 lanes plus RPM drop lane

Direction of Travel





Note: Striping NOT to be on shoulder.

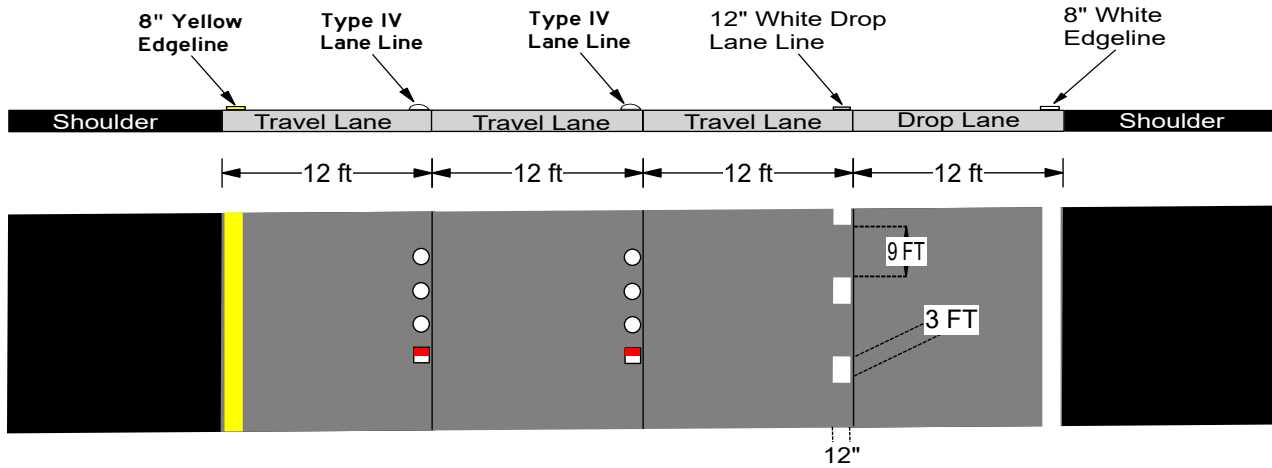
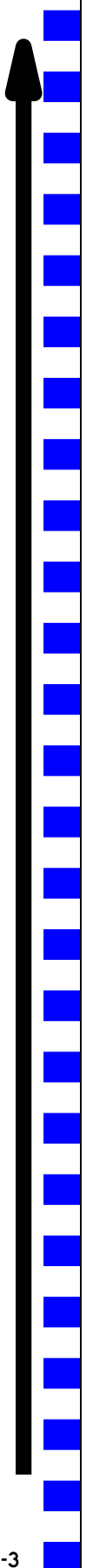

### 3 lanes plus drop lane

Direction of Travel

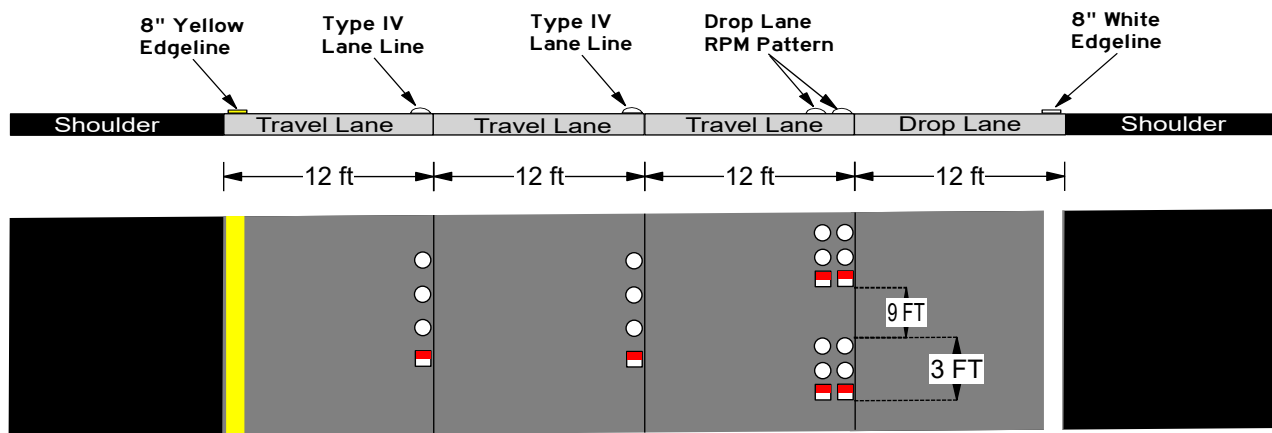

### 3 lanes plus RPM drop lane



Note: Striping NOT to be on shoulder.

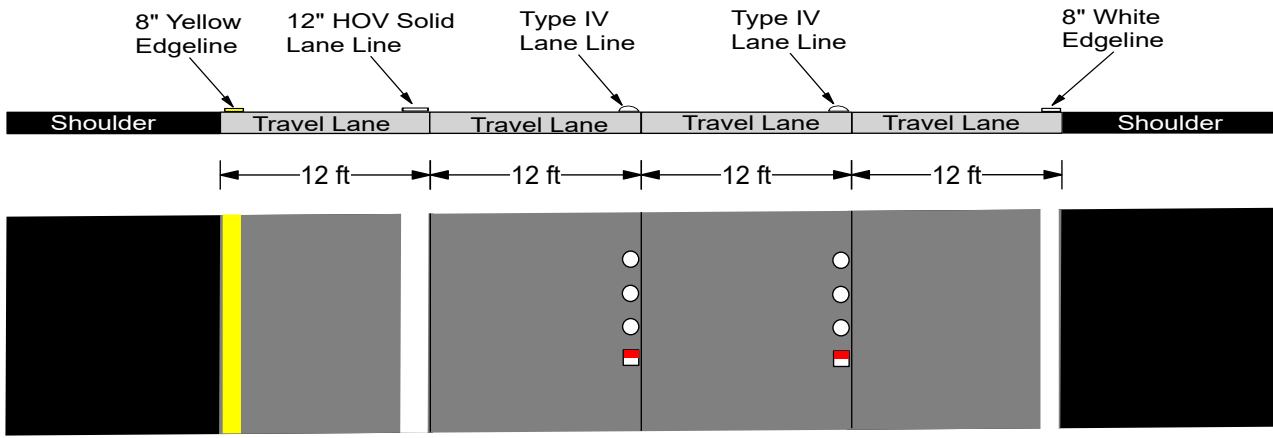

# 3 lanes plus HOV permissive enter/exit Correct Marking for Controlled Access Facilities

Direction of Travel



# Pavement Marking Placement

## Correct

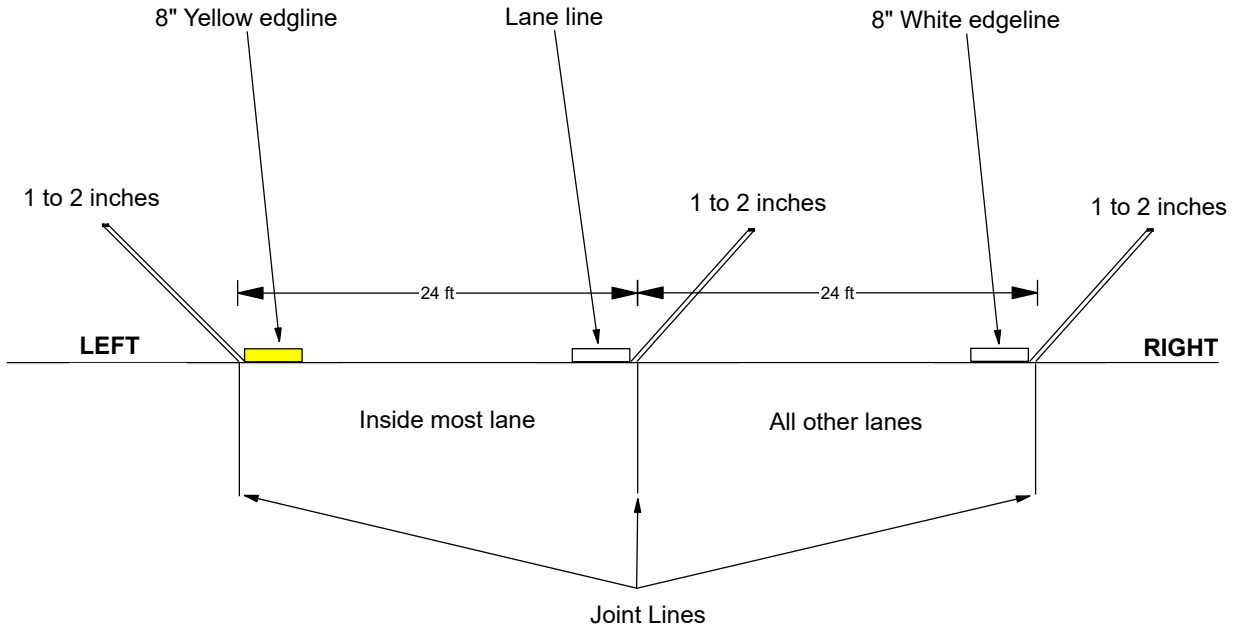

Edgelines are to be installed on the roadway, not the shoulder..

## Incorrect

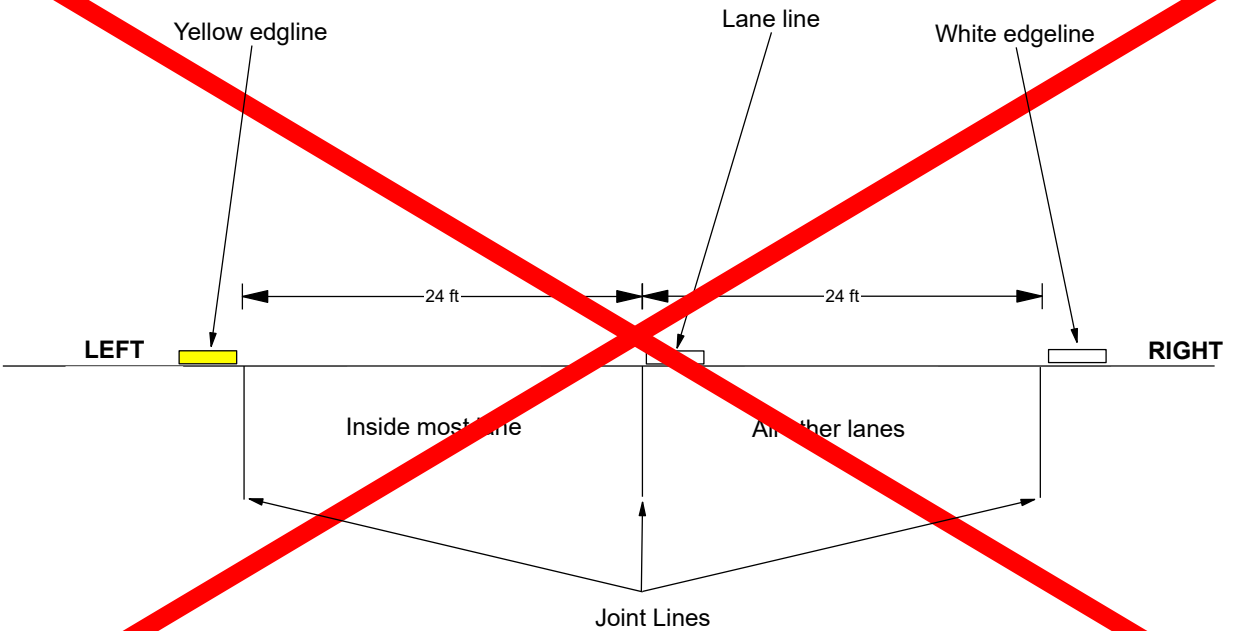

# INCORRECT Marking locations

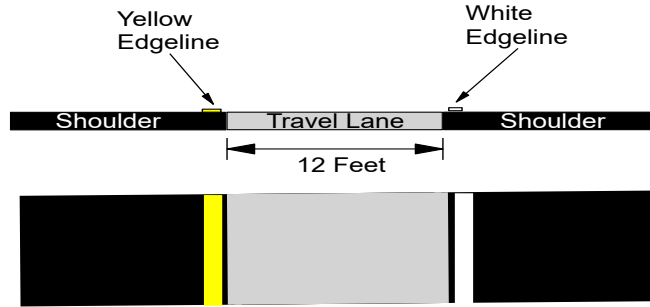

1 lane

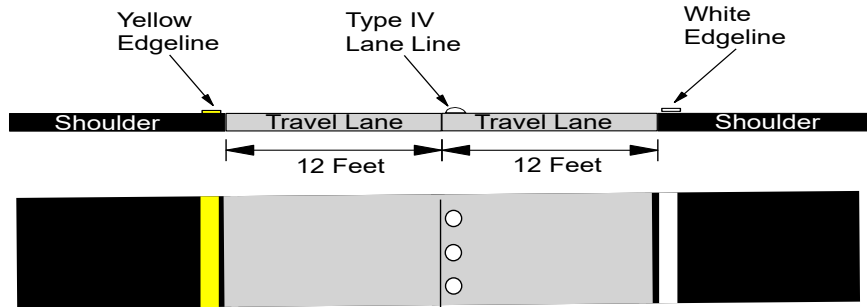

2 lanes

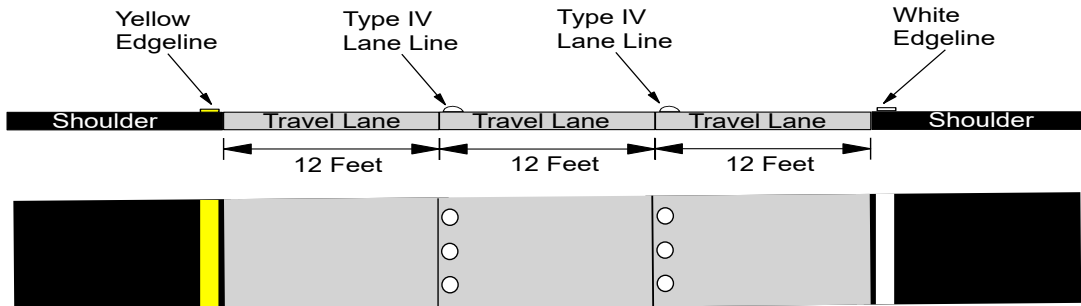

3 lanes

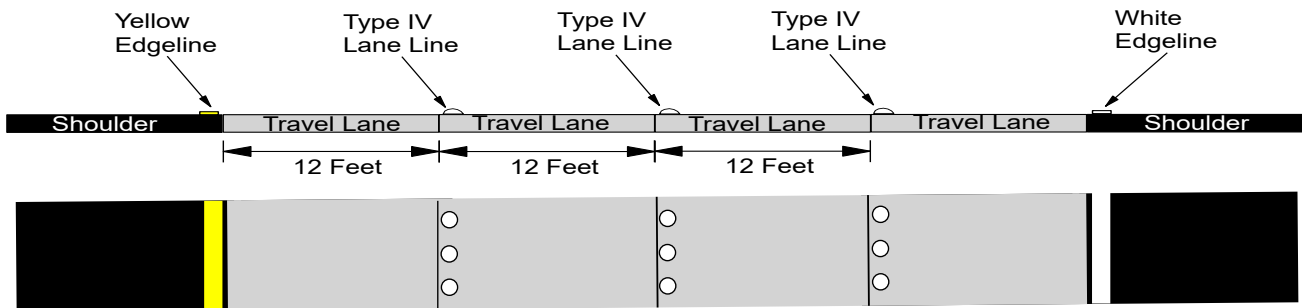

4 lanes

Direction of Travel



# INCORRECT Marking locations

# Examples of Skip Line and Channelizing Line Applications for Exit Ramp Markings (Sheet 1 of 2)

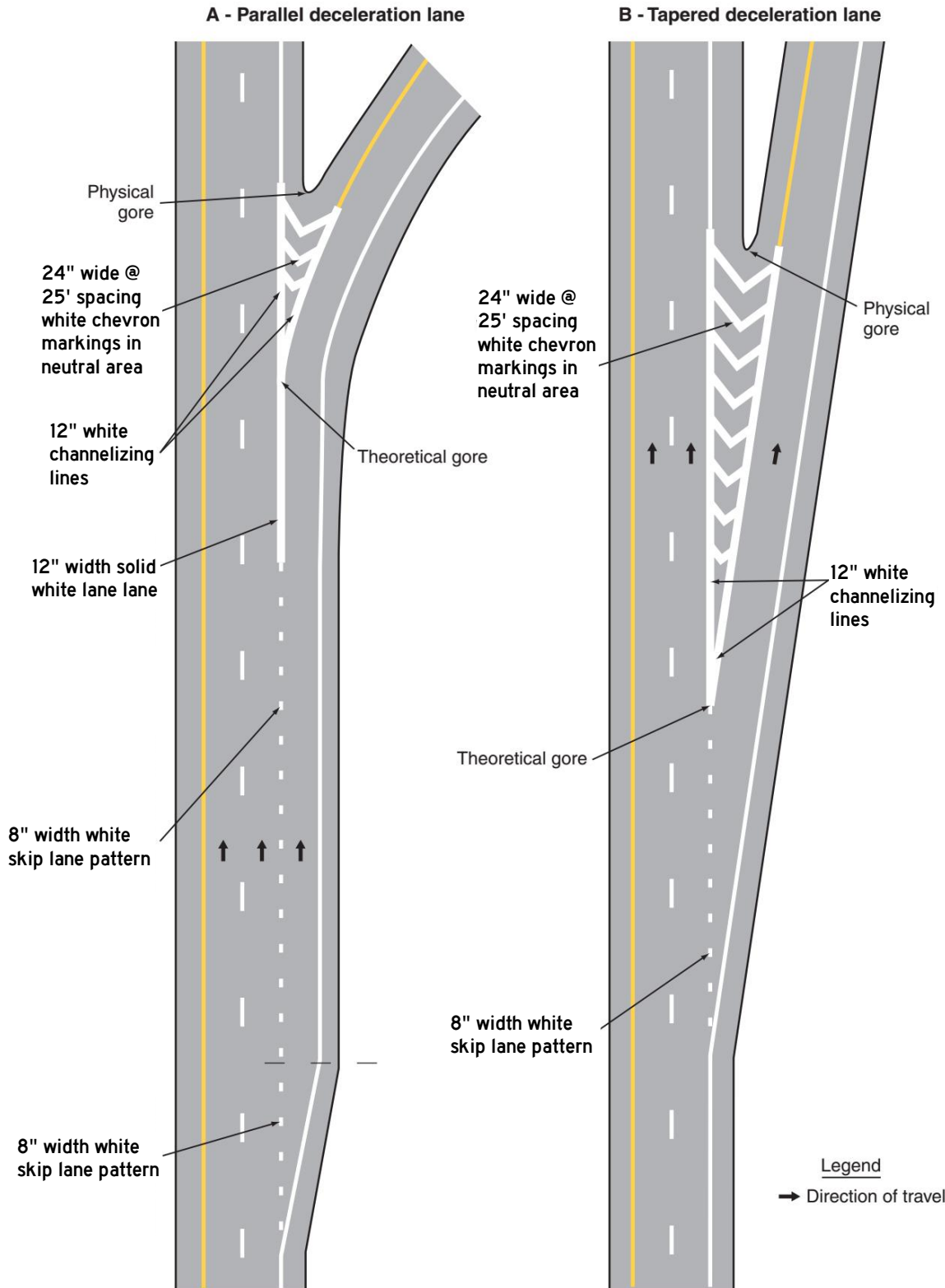

# Examples of Skip Line and Channelizing Line Applications for Exit Ramp Markings (Sheet 2 of 2)

C – Parallel deceleration lane at a multi-lane exit ramp having an optional exit lane that also carries the through route

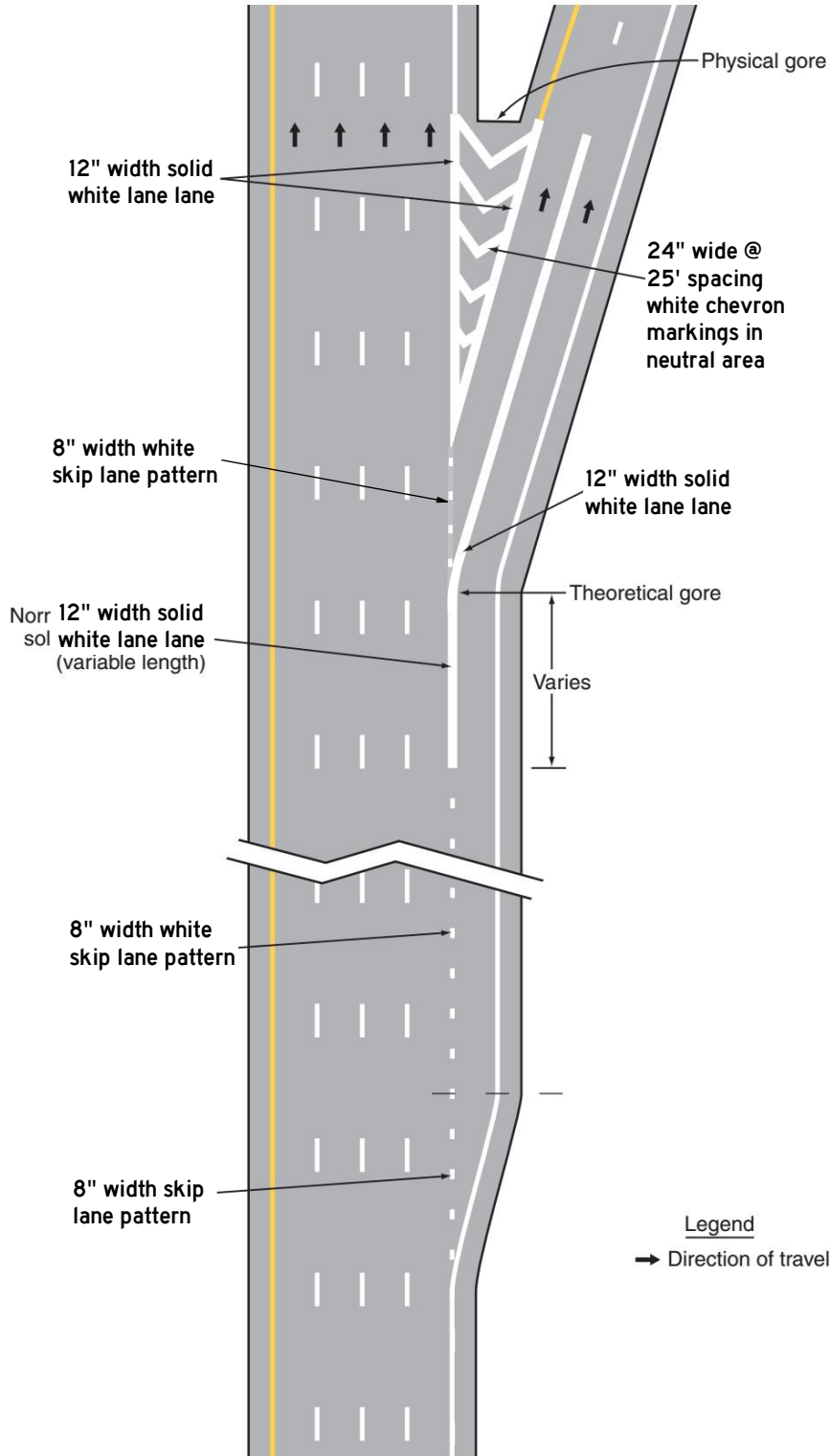

# Examples of Skip Line and Channelizing Line Applications for Entrance Ramp Markings

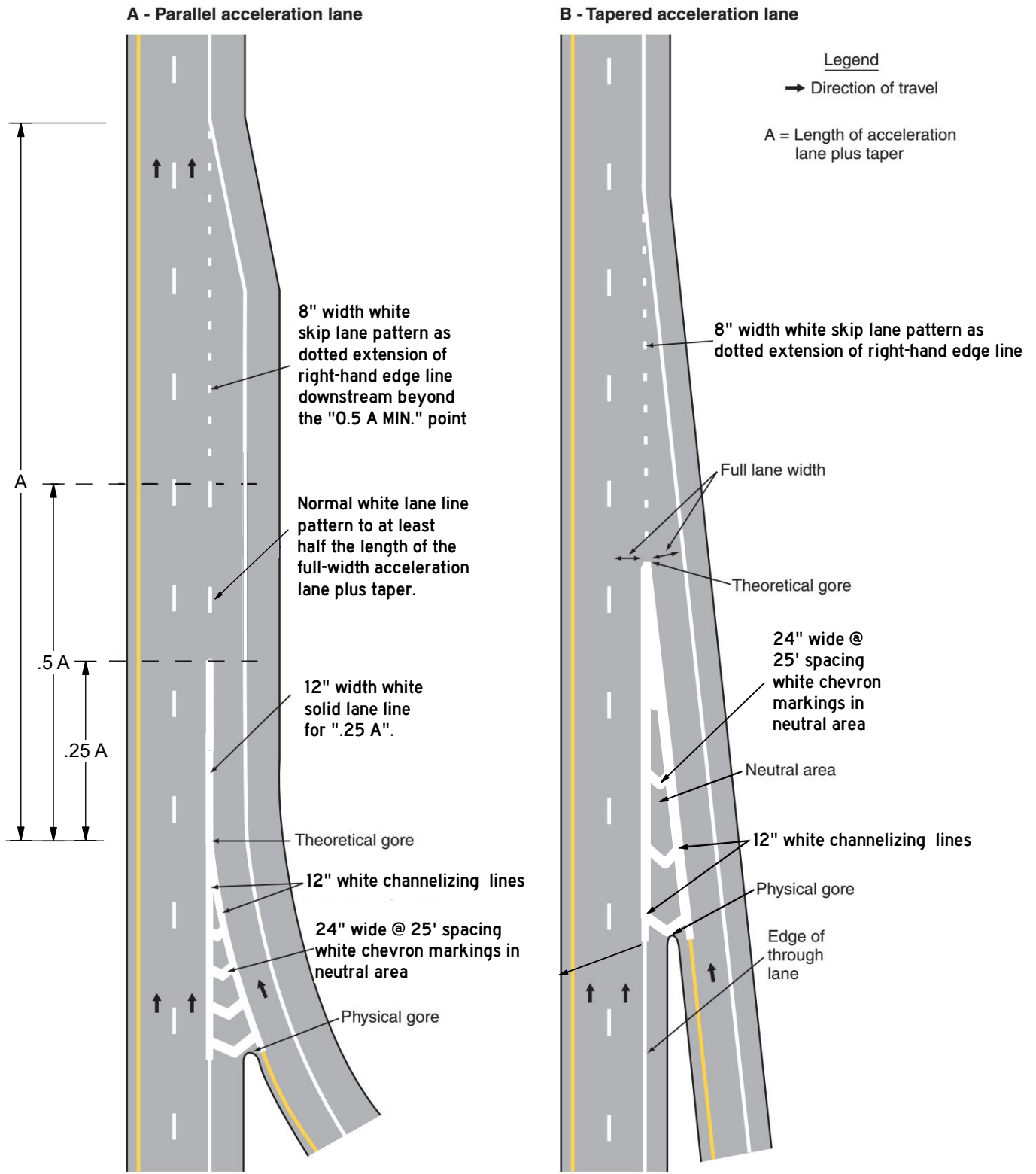

# Examples of Drop Lane and Channelizing Line Applications for Lane-Drop Markings (Sheet 1 of 3)

A – Lane drop at a single lane exit ramp

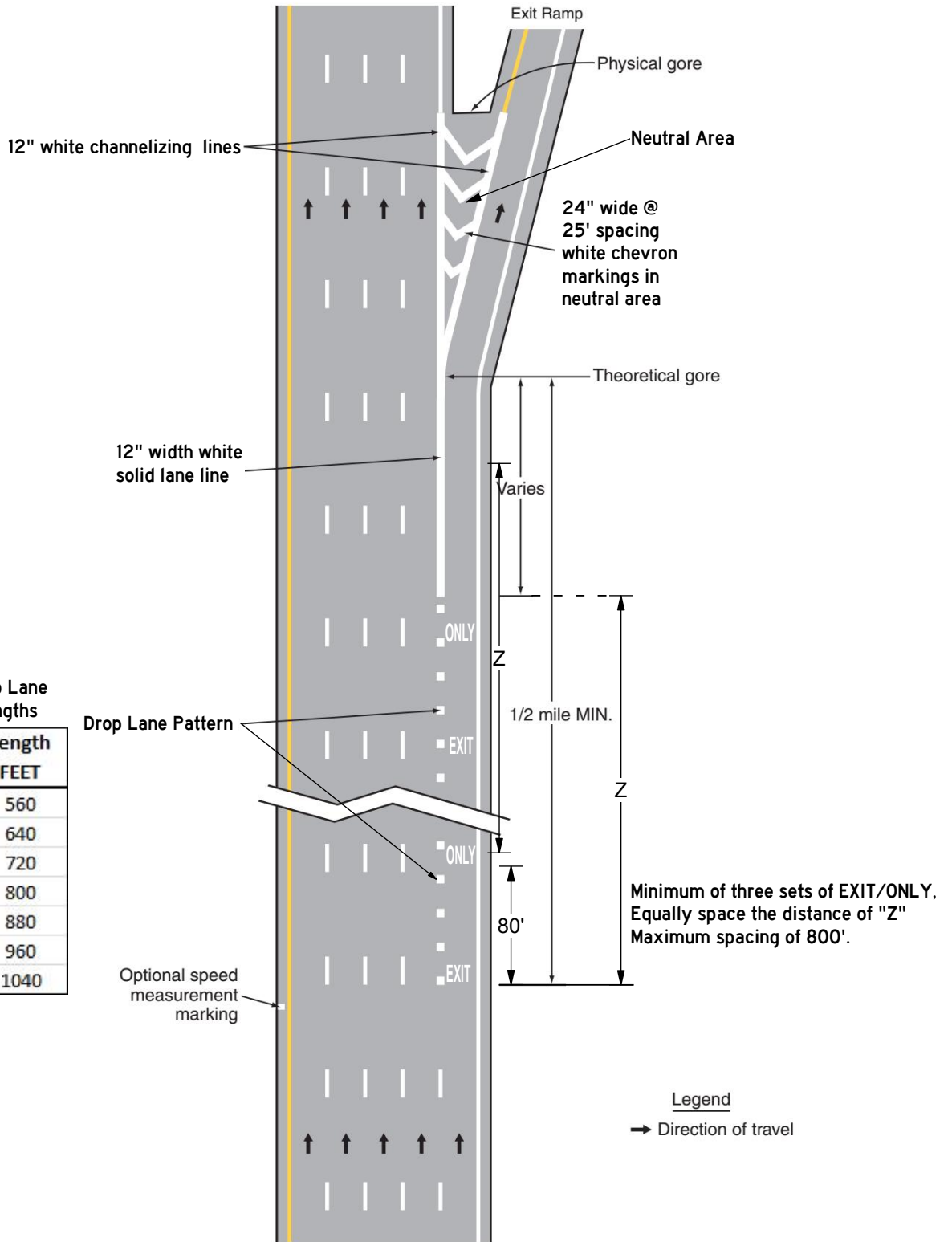

Typical Drop Lane Pattern Lengths

Posted Speed, MPH	Length FEET
45	560
50	640
55	720
60	800
65	880
70	960
75	1040





# Examples of Drop Lane and Channelizing Line Applications for Lane-Drop Markings (Sheet 2 of 3)

B – Lane drop at a multi-lane exit ramp having an optional exit lane that also carries the through route

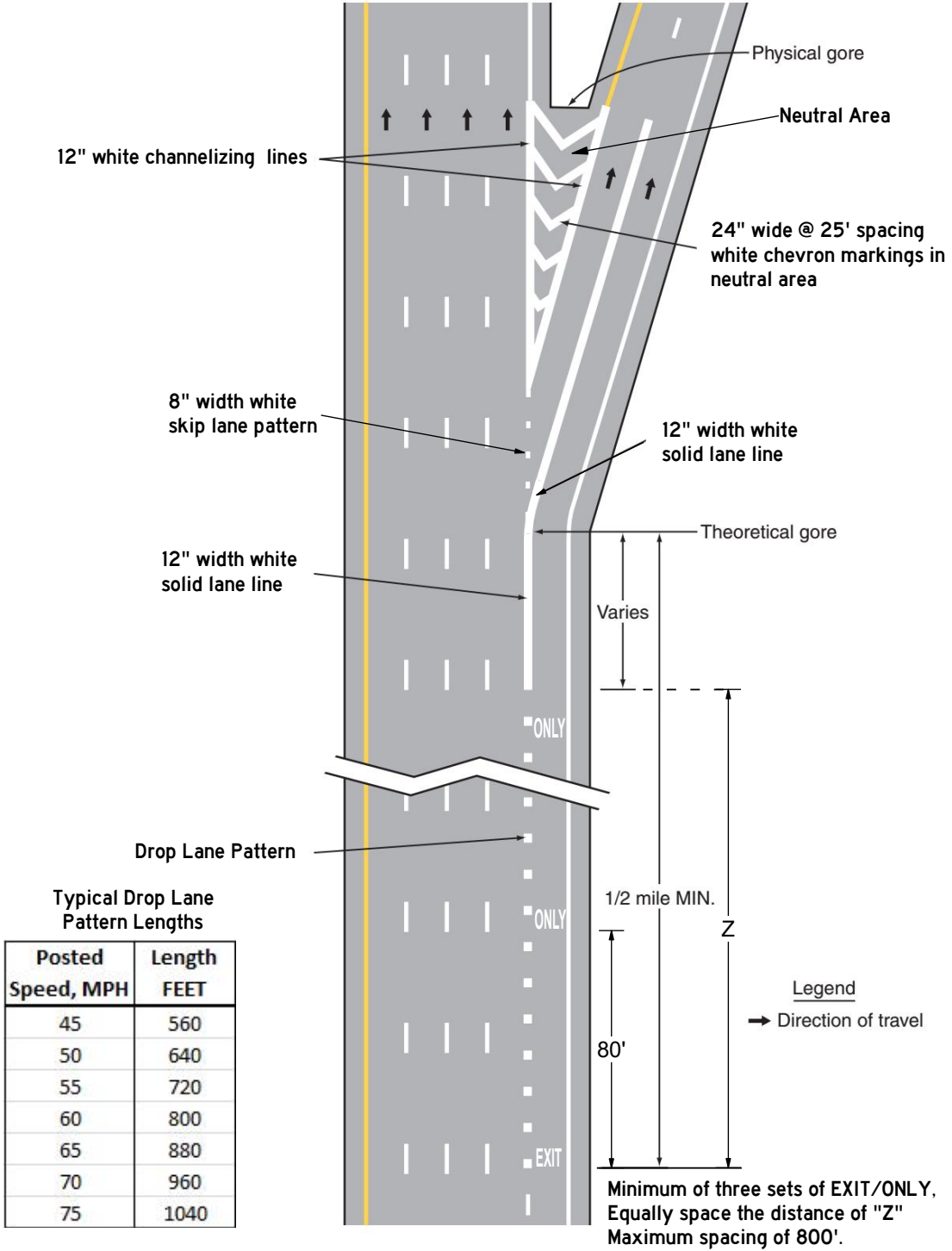

Typical Drop Lane Pattern Lengths

Posted Speed, MPH	Length FEET
45	560
50	640
55	720
60	800
65	880
70	960
75	1040

# Examples of Drop Lane and Channelizing Line Applications for Lane-Drop Markings (Sheet 3 of 3)

C - Auxiliary lane between ramps

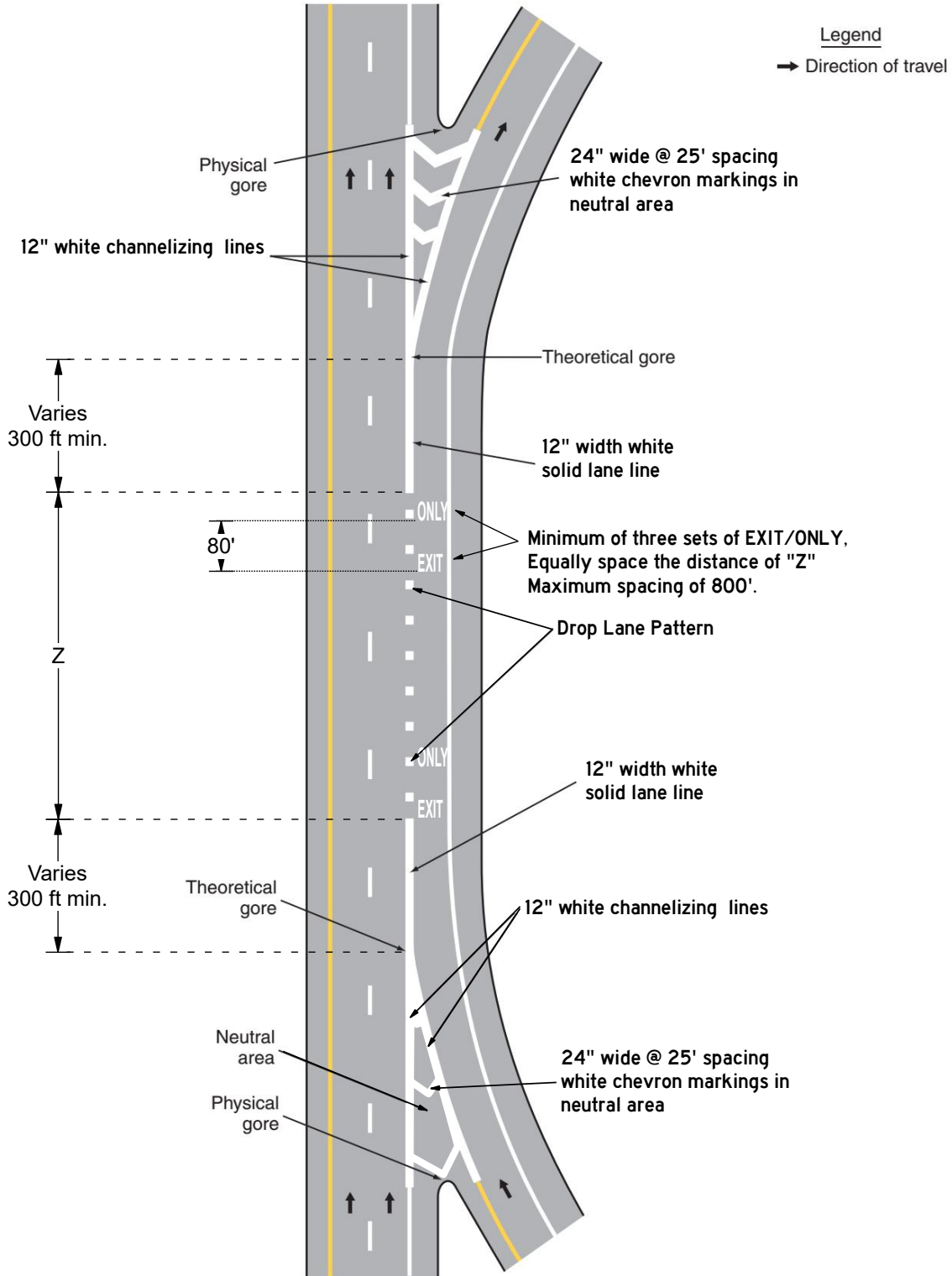

# Edgeline and gore marking locations

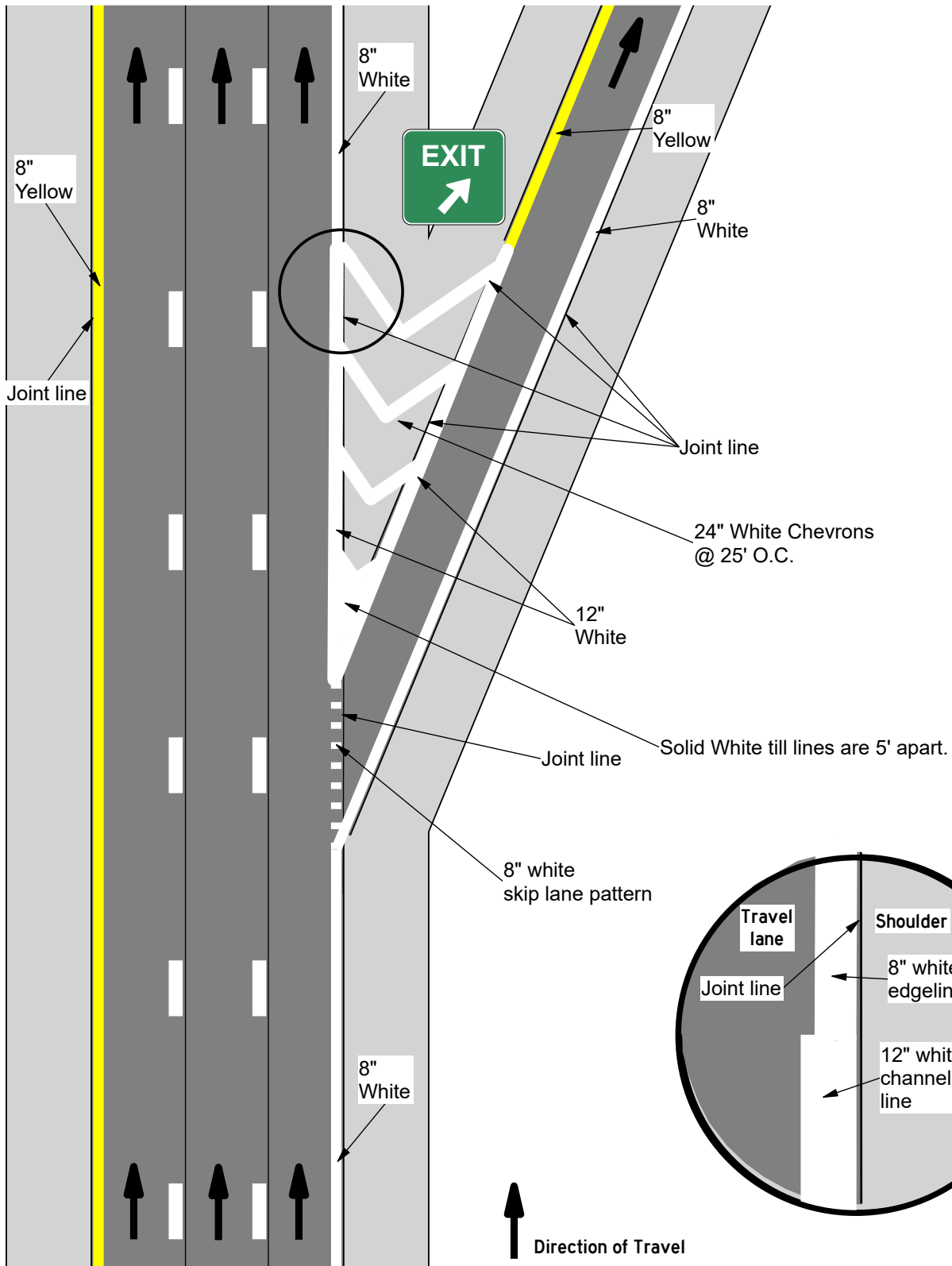

# Clark County

# Shifts and Tapers



# Examples of Applications of Lane-Reduction Transition Markings.

**A - Lane Reduction**

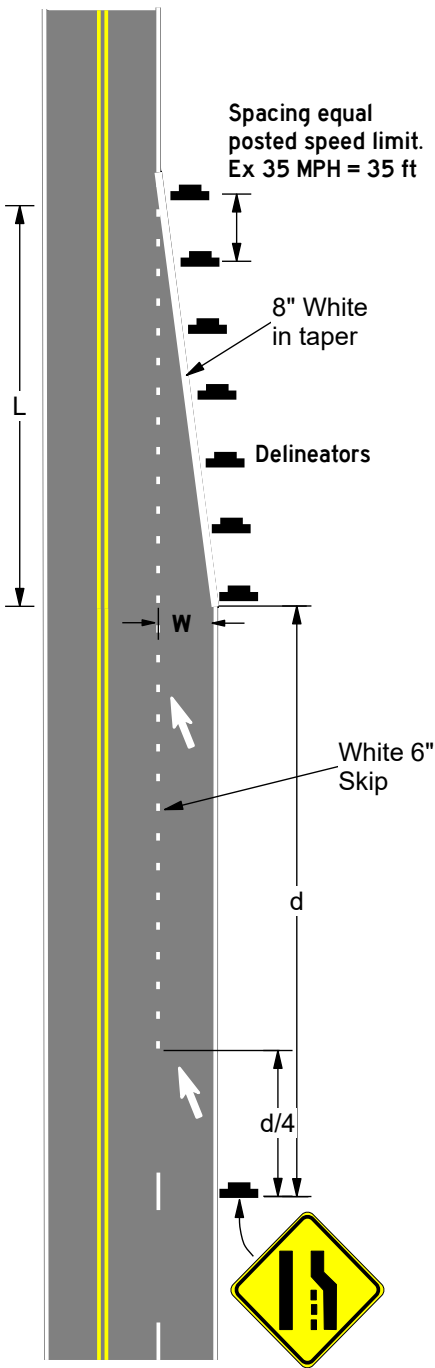

**B - Lane Reduction with lateral shift to left**

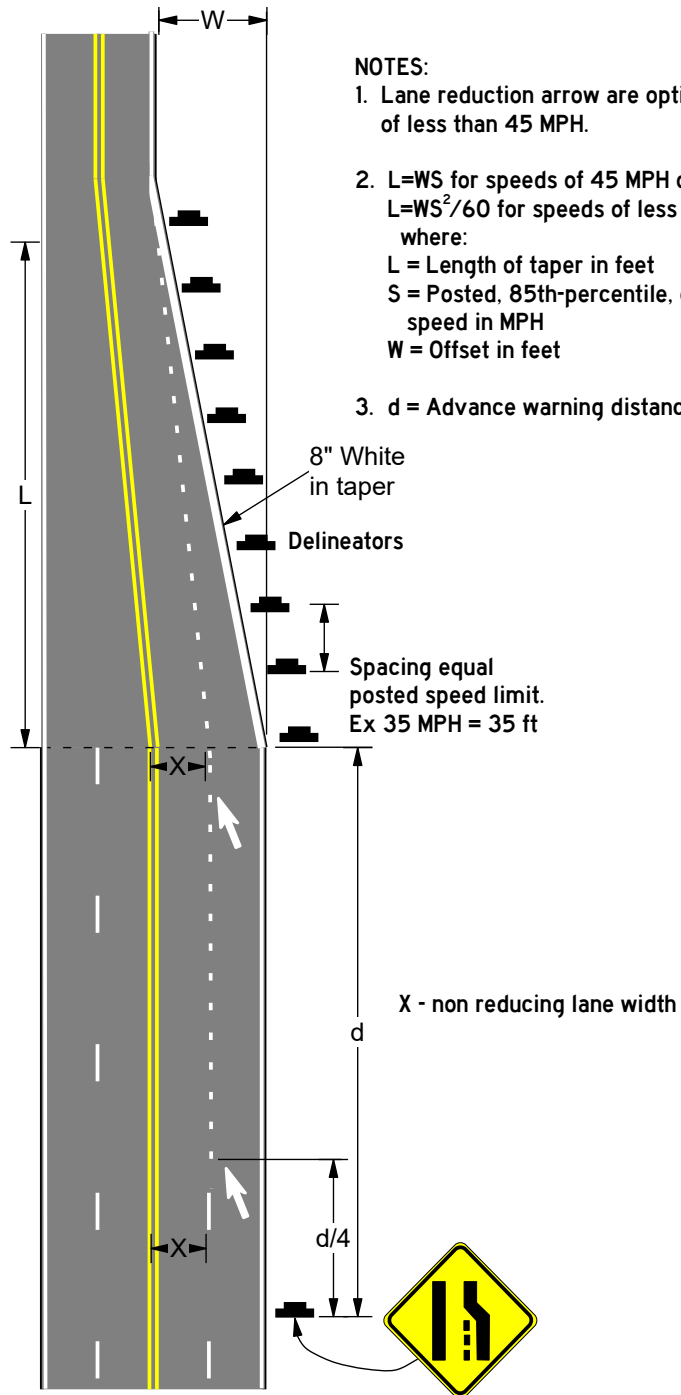

**NOTES:**

1. Lane reduction arrow are optional for speeds of less than 45 MPH.
2.  $L=WS$  for speeds of 45 MPH or greater.  
 $L=WS^2/60$  for speeds of less than 45 MPH.  
 where:  
 $L$  = Length of taper in feet  
 $S$  = Posted, 85th-percentile, or statutory speed in MPH  
 $W$  = Offset in feet
3.  $d$  = Advance warning distance in feet

S, MPH	d, ft	1/4d, ft	3/4d, ft	L, ft for 12 ft
25	325	81	244	125
30	460	115	345	180
35	565	141	424	245
40	570	143	428	320
45	775	194	581	540
50	885	221	664	600
55	990	248	743	660
60	1100	275	825	720
65	1200	300	900	780
70	1250	313	938	840

Chart based on Section 2C.05





## Lane transitions

Change in offset, feet

Speed	1	2	3	4	5	6	7	8	9	10	11	12	13	14	15	16	17	18	19	20	21	22	23	24
15	4	8	11	15	19	23	26	30	34	38	41	45	49	53	56	60	64	68	71	75	79	83	86	90
20	7	13	20	27	33	40	47	53	60	67	73	80	87	93	100	107	113	120	127	133	140	147	153	160
25	10	21	31	42	52	63	73	83	94	104	115	125	135	146	156	167	177	188	198	208	219	229	240	250
30	15	30	45	60	75	90	105	120	135	150	165	180	195	210	225	240	255	270	285	300	315	330	345	360
35	20	41	61	82	102	123	143	163	184	204	225	245	265	286	306	327	347	368	388	408	429	449	470	490
40	27	53	80	107	133	160	187	213	240	267	293	320	347	373	400	427	453	480	507	533	560	587	613	640
45	45	90	135	180	225	270	315	360	405	450	495	540	585	630	675	720	765	810	855	900	945	990	1035	1080
50	50	100	150	200	250	300	350	400	450	500	550	600	650	700	750	800	850	900	950	1000	1050	1100	1150	1200
55	55	110	165	220	275	330	385	440	495	550	605	660	715	770	825	880	935	990	1045	1100	1155	1210	1265	1320
60	60	120	180	240	300	360	420	480	540	600	660	720	780	840	900	960	1020	1080	1140	1200	1260	1320	1380	1440
65	65	130	195	260	325	390	455	520	585	650	715	780	845	910	975	1040	1105	1170	1235	1300	1365	1430	1495	1560
70	70	140	210	280	350	420	490	560	630	700	770	840	910	980	1050	1120	1190	1260	1330	1400	1470	1540	1610	1680

Change in offset, feet

Speed	25	26	27	28	29	30	31	32	33	34	35	36	37	38	39	40	41	42	43	44	45	46	47	48
15	94	98	101	105	109	113	116	120	124	128	131	135	139	143	146	150	154	158	161	165	169	173	176	180
20	167	173	180	187	193	200	207	213	220	227	233	240	247	253	260	267	273	280	287	293	300	307	313	320
25	260	271	281	292	302	313	323	333	344	354	365	375	385	396	406	417	427	438	448	458	469	479	490	500
30	375	390	405	420	435	450	465	480	495	510	525	540	555	570	585	600	615	630	645	660	675	690	705	720
35	510	531	551	572	592	613	633	653	674	694	715	735	755	776	796	817	837	858	878	898	919	939	960	980
40	667	693	720	747	773	800	827	853	880	907	933	960	987	1013	1040	1067	1093	1120	1147	1173	1200	1227	1253	1280
45	1125	1170	1215	1260	1305	1350	1395	1440	1485	1530	1575	1620	1665	1710	1755	1800	1845	1890	1935	1980	2025	2070	2115	2160
50	1250	1300	1350	1400	1450	1500	1550	1600	1650	1700	1750	1800	1850	1900	1950	2000	2050	2100	2150	2200	2250	2300	2350	2400
55	1375	1430	1485	1540	1595	1650	1705	1760	1815	1870	1925	1980	2035	2090	2145	2200	2255	2310	2365	2420	2475	2530	2585	2640
60	1500	1560	1620	1680	1740	1800	1860	1920	1980	2040	2100	2160	2220	2280	2340	2400	2460	2520	2580	2640	2700	2760	2820	2880
65	1625	1690	1755	1820	1885	1950	2015	2080	2145	2210	2275	2340	2405	2470	2535	2600	2665	2730	2795	2860	2925	2990	3055	3120
70	1750	1820	1890	1960	2030	2100	2170	2240	2310	2380	2450	2520	2590	2660	2730	2800	2870	2940	3010	3080	3150	3220	3290	3360







# Sign Type Determination





# EXIT v RAMP Advisory Speed Sign

(W13-2) (W13-3)

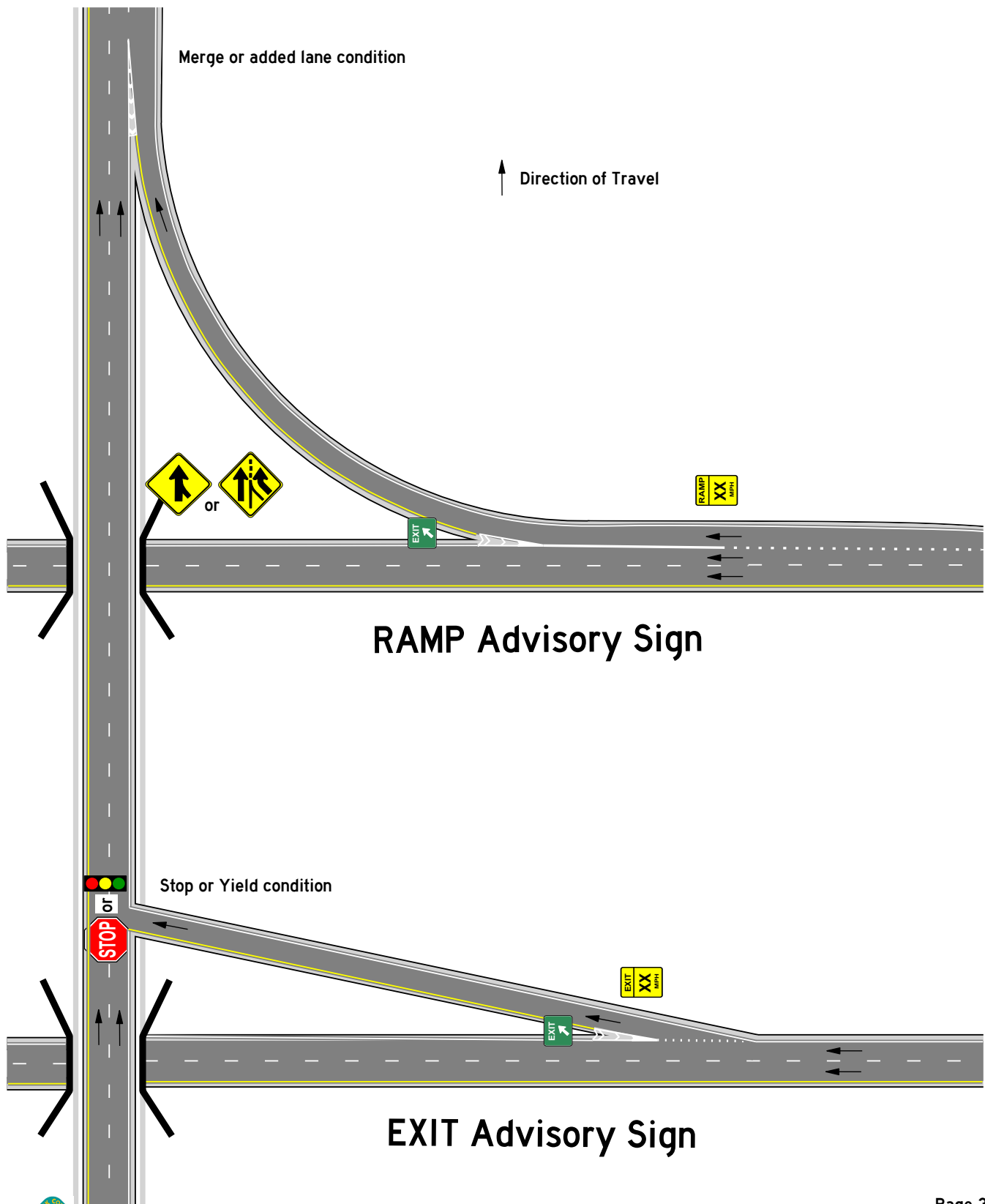

# MERGE v ADDED LANE Sign

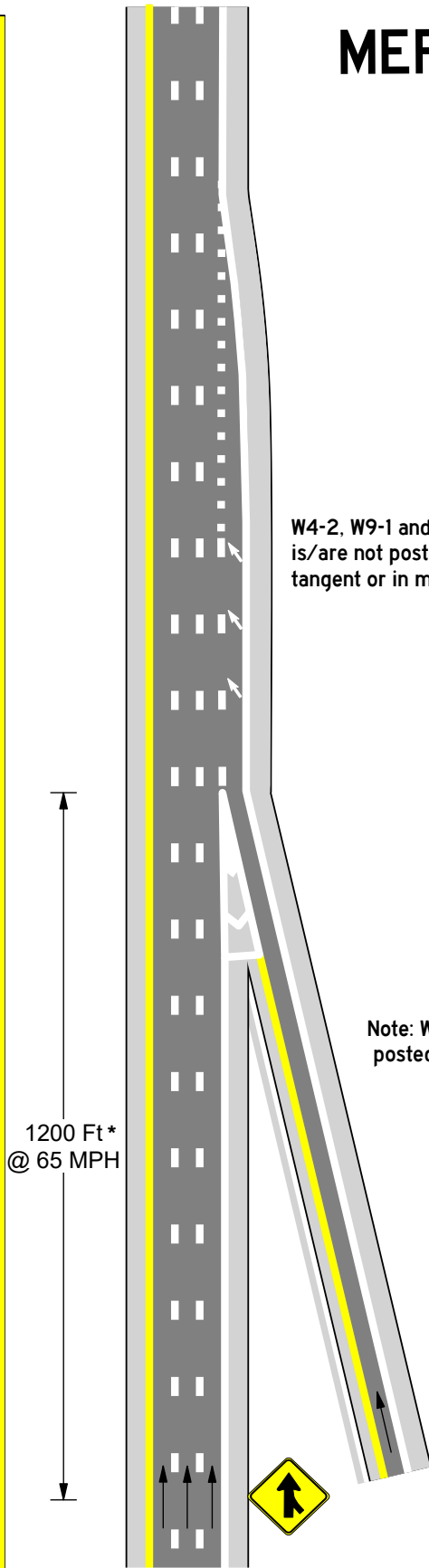

Merge - Use W4-1

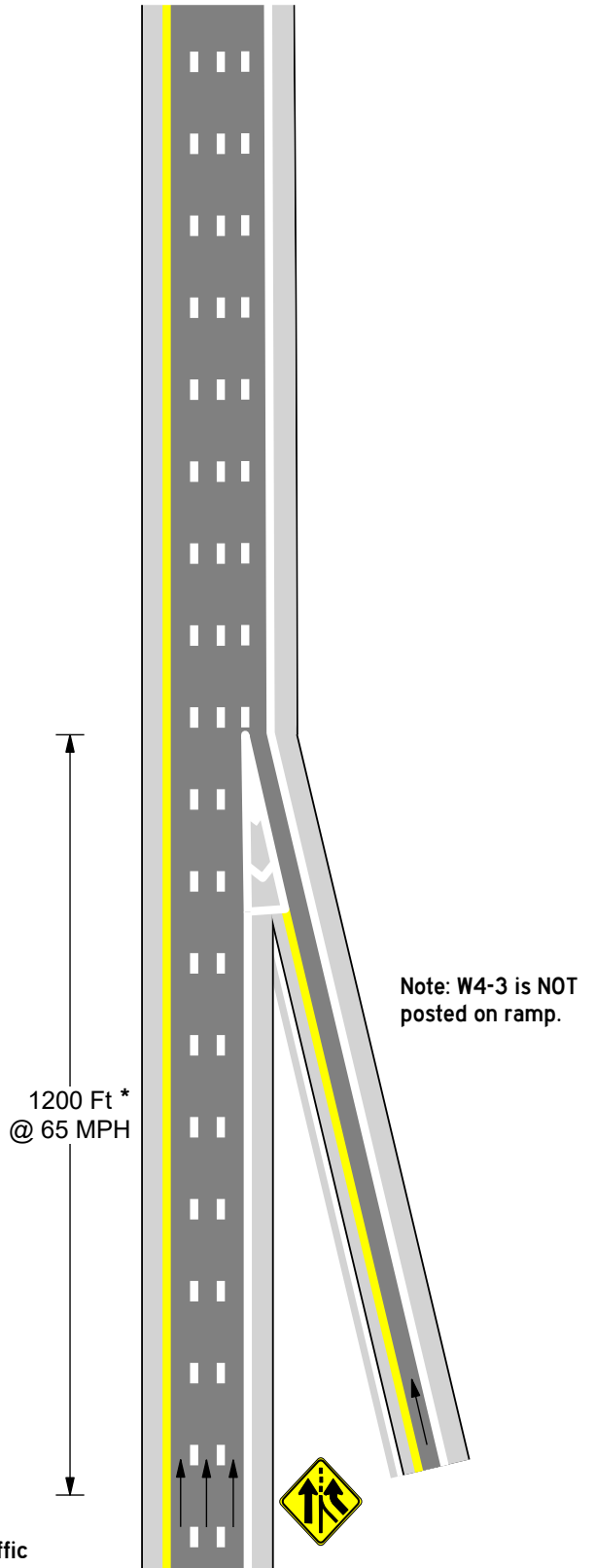

Added Lane - Use W4-3

\* Per Table 2C-4

